

# caadre

Philippe Starck

modello registrato  
registered model



Specchio da parete o da terra con cornice formata da quattro elementi singoli in vetro da 6 mm curvato e retroargentato, oppure retroverniciato con tinte speciali metallescenti. Disponibile anche in vetro semiriflettente color Titanio o in vetro bronzo retroargentato. Possibilità di appendimento in orizzontale o verticale. Disponibile anche su misura e in configurazioni modulari. Kit di retro-illuminazione a LED, dimmerabile e con regolazione della temperatura (opzionale).

Hanging or leaning mirror in 6 mm-thick curved glass, made of four separate curved elements, back-silvered or back-painted with special metallic paints. Also available with semi-reflective glass titanium finish or in back-silvered bronze glass. It can be hung horizontally or vertically. Also available custom-sized and in modular configurations. LED lighting kit with a dimmer switch and temperature regulation (optional).

## SPECCHIO DA PARETE HANGING MIRROR

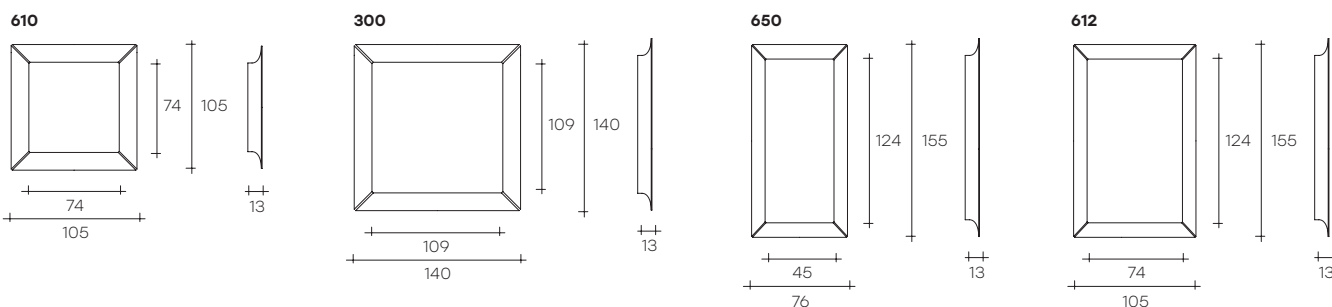

## SPECCHIO DA PARETE O DA TERRA HANGING OR LEANING MIRROR

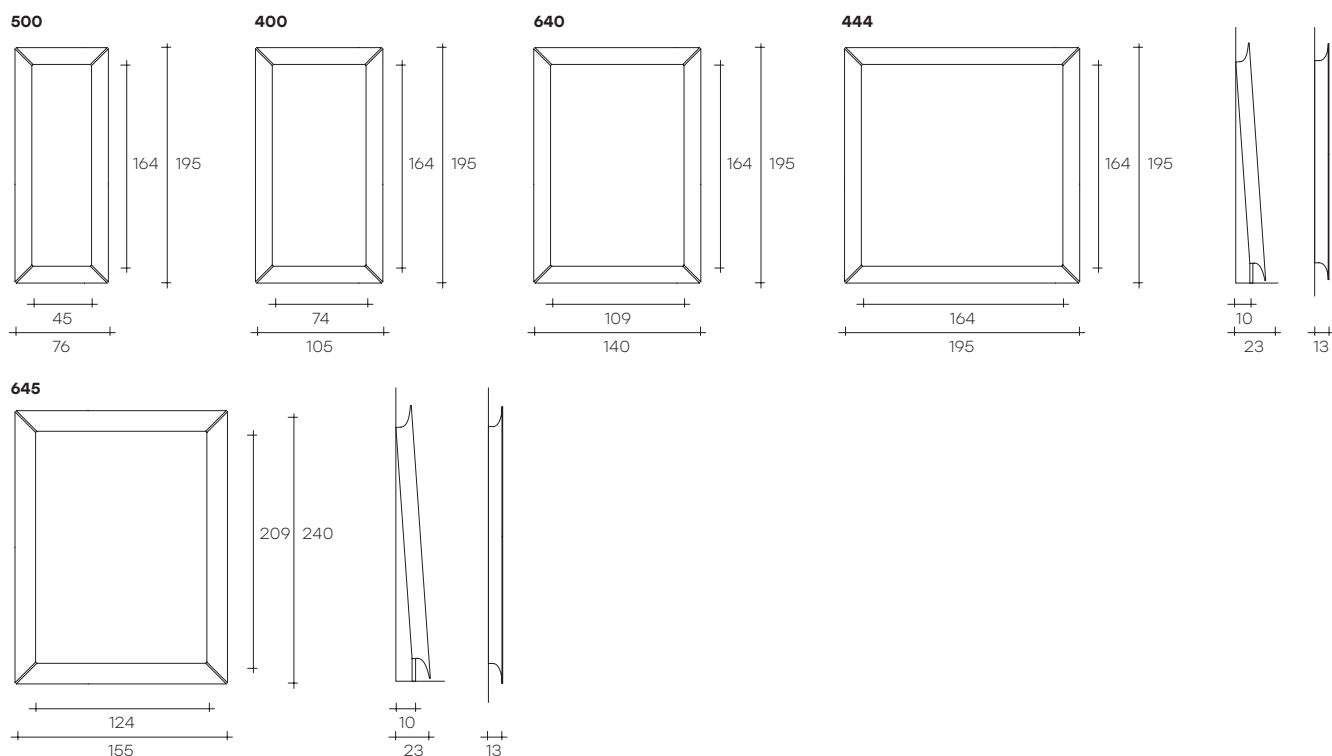

## DIMENSIONI \_ DIMENSIONS

<b>610</b> L 105 x P 13 x H 105 cm L 41 1/3" x W 5 1/8" x H 41 1/3"	 22  51  0,42	<b>300</b> L 140 x P 13 x H 140 cm L 55 1/8" x W 5 1/8" x H 55 1/8"	 40  85  0,75	<b>640°</b> L 140 x P 13 x H 195 cm L 55 1/8" x W 5 1/8" x H 76 3/4"	 55  105  0,88
<b>650</b> L 76 x P 13 x H 155 cm L 29 15/16" x W 5 1/8" x H 61"	 26  54  0,43	<b>500°</b> L 76 x P 13 x H 195 cm L 29 15/16" x W 5 1/8" x H 76 3/4"	 35  75  0,60	<b>444°</b> L 195 x P 13 x H 195 cm L 76 3/4" x W 5 1/8" x H 76 3/4"	 80  160  1,23
<b>612</b> L 105 x P 13 x H 155 cm L 41 1/3" x W 5 1/8" x H 61"	 31  71  0,60	<b>400°</b> L 105 x P 13 x H 195 cm L 41 1/3" x W 5 1/8" x H 76 3/4"	 44  92  0,74	<b>645°</b> L 155 x P 13 x H 240 cm L 61" x W 5 1/8" x H 94 1/2"	 74  139  1,20

- ° Modelli forniti con piedini smontabili per versione da terra.
- ° Items provided with removable feet for free standing version.

## CORNICE IN VETRO CURVATO CURVED GLASS FRAME



AG  
Retroargentato  
Back-silvered



TN  
Titanio  
(semifillettente  
retroverniciato nero)  
Titanium  
(black back-painted  
semi-reflecting glass)



BR-AG  
Bronzo  
retroargentato  
Back-silvered  
Bronze



VUS  
Retroverniciato  
Vulcano Special  
back-painted  
glass

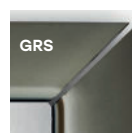

GRS  
Retroverniciato  
Greige Special  
back-painted  
glass





CHS  
Retroverniciato  
Champagne  
Special  
back-painted  
glass

## DIMENSIONI SU RICHIESTA CUSTOM DIMENSIONS

Dimensioni realizzabili a misura: minimo 76x76 cm - massimo 240x155 cm (rettangolare) e 195x195 cm (quadrato).  
Custom dimensions: min 76x76 cm - max 240x155 cm (rectangular) and 195x195 cm (square).

## ILLUMINAZIONE LED \_ LED LIGHTING SYSTEM

Kit di retro-illuminazione a LED, dimmerabile e con regolazione della temperatura.  
LED lighting kit with a dimmer switch and temperature regulation.

COD. SPECCHIO MIRROR CODE	COD. KIT LUCE KIT CODE			
500	<b>LED/500</b>	2	4	0,04
400	<b>LED/400</b>	2	4	0,04
640	<b>LED/640</b>	2,5	4,5	0,04
444	<b>LED/444</b>	3	5	0,04
645	<b>LED/645</b>	4	6	0,05

Prodotto marcato CE, disponibile solo per mercato europeo.  
CE certification, only for European countries available.

**CAADRE MODULARE**  
**CAADRE IN MODULAR CONFIGURATIONS**

Per dimensioni superiori a 240x155 cm (rettangolare) e 195x195 cm (quadrato), lo specchio verrà realizzato in moduli.  
 For dimensions over 240x155 cm (rectangular) and 195x195 cm (square), the mirror will be made in modules.

**MODULI DISPONIBILI**  
**AVAILABLE MODULES**

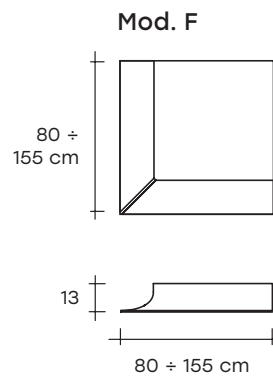
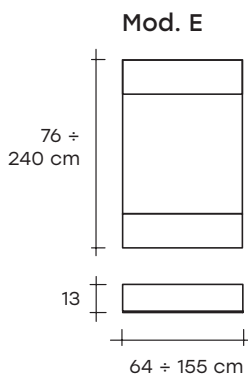
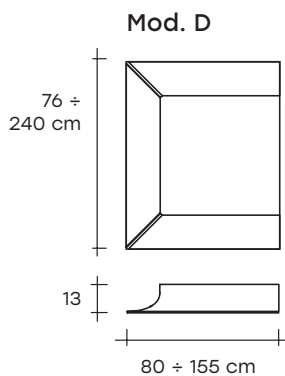
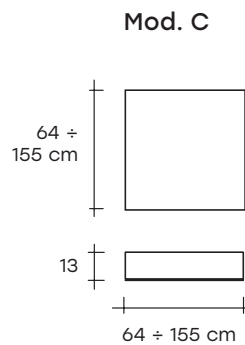
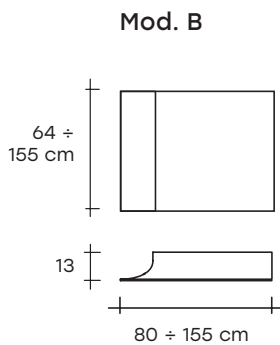
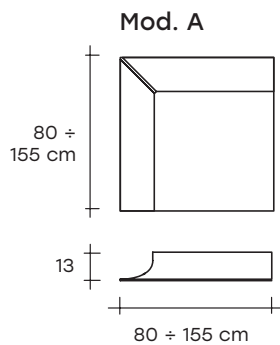

**ESEMPI DI CONFIGURAZIONI MODULARI**  
**EXAMPLES OF MODULAR CONFIGURATIONS**

