

78
3.1

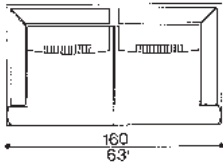

ML 01

90
35



ML 02

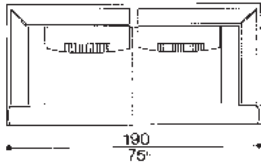

ML 03

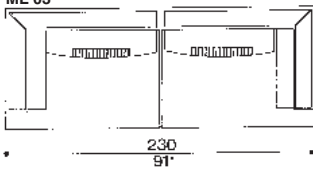

ML 04

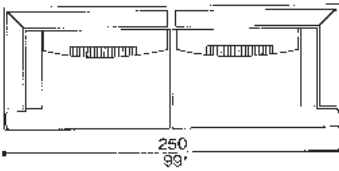

ML 05

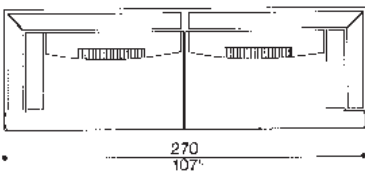

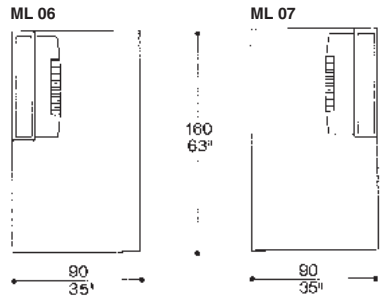

2 ▶

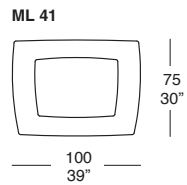
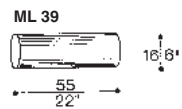
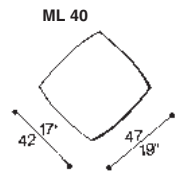
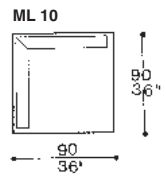
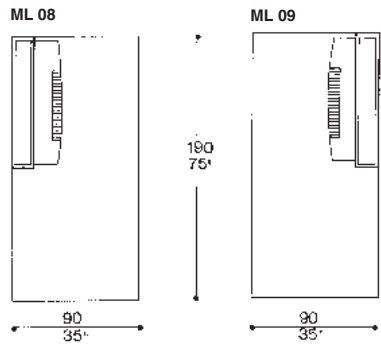

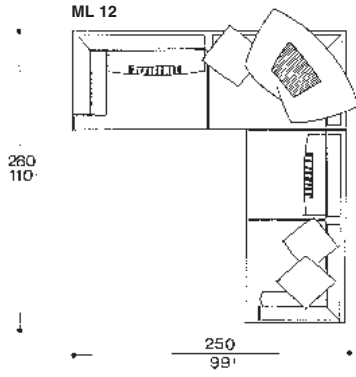
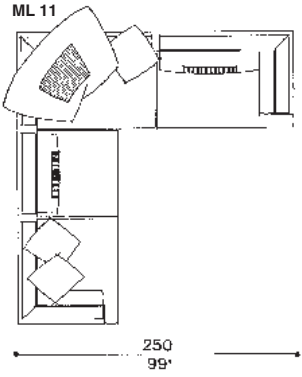

280
110'

3 ▶

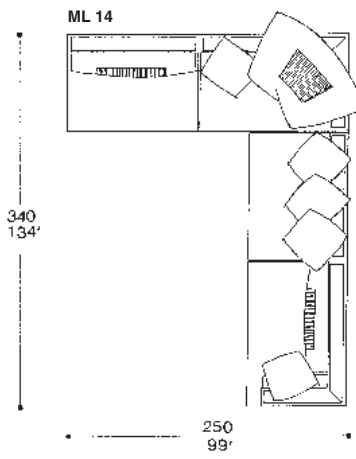
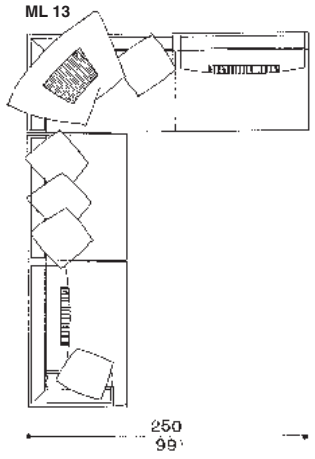

340
134'

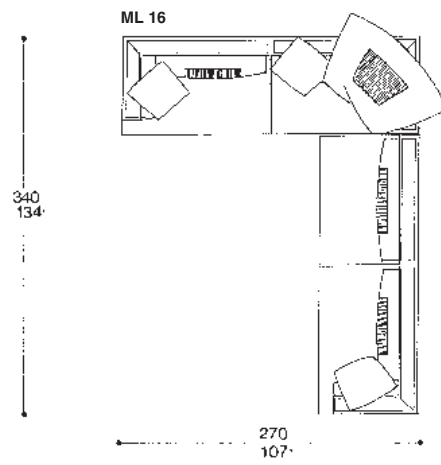
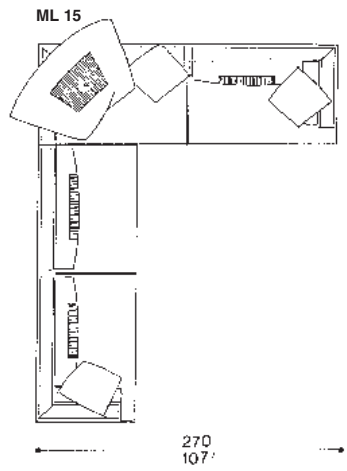

4 ▶

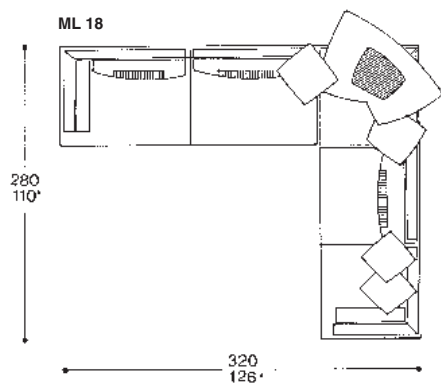
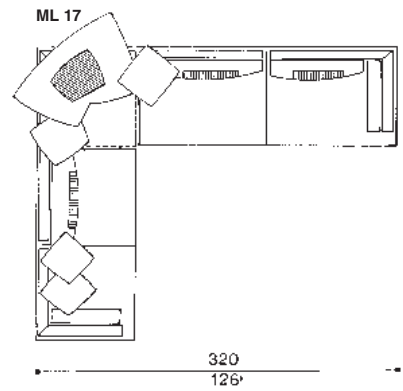

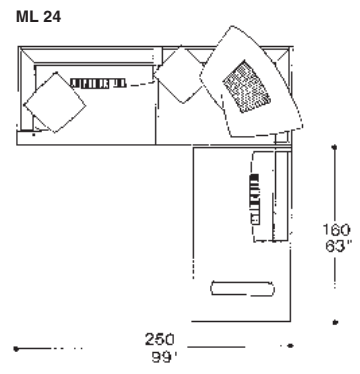
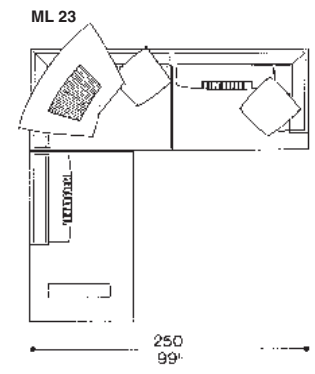
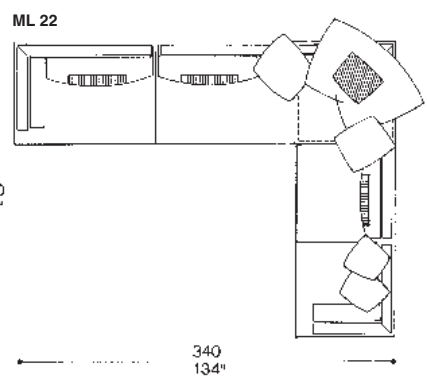
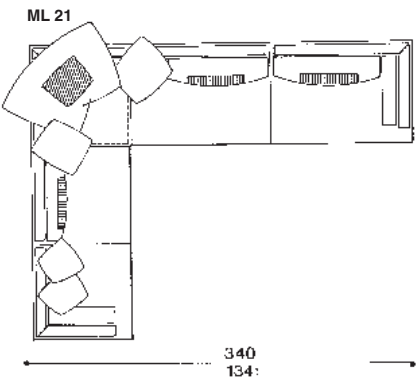
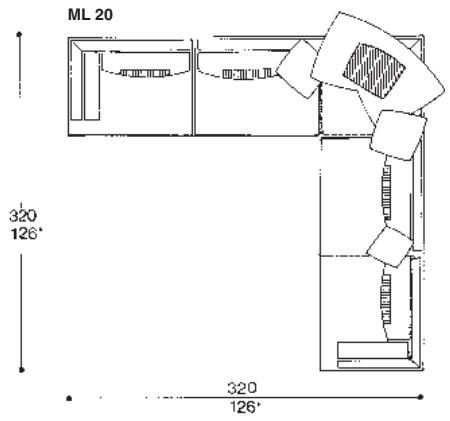
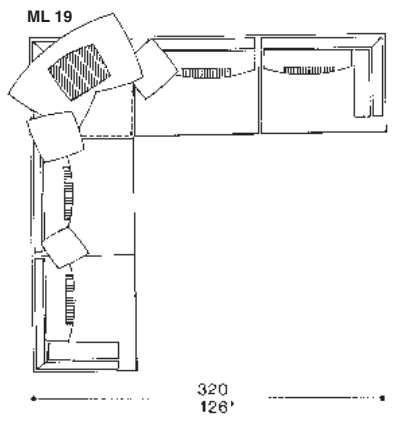

5 ▶

ML 25

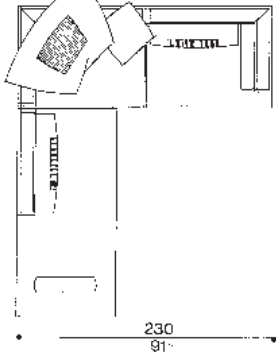

ML 26

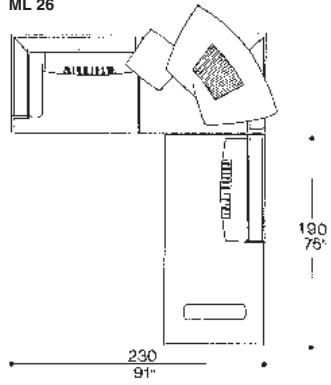

ML 27

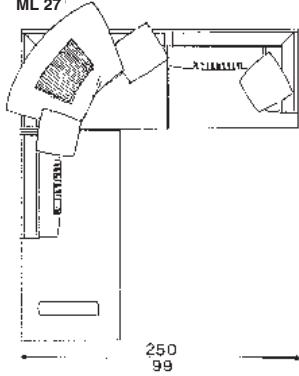

ML 28

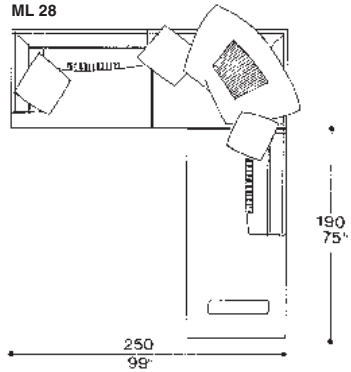

ML 29

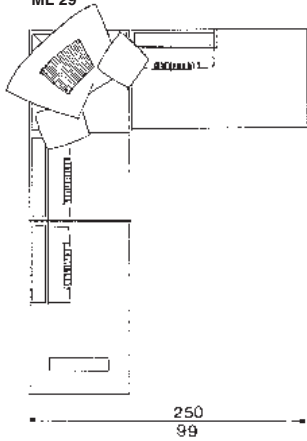

ML 30

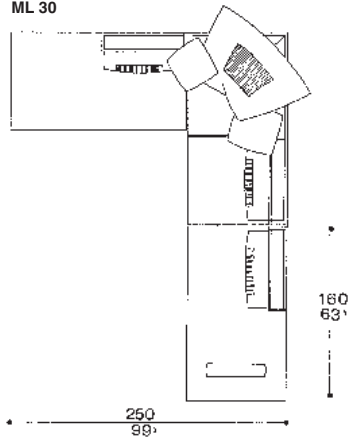

ML 31

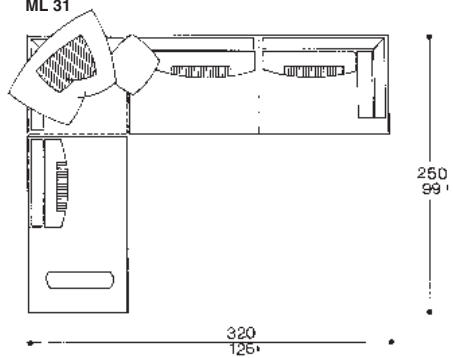

ML 32

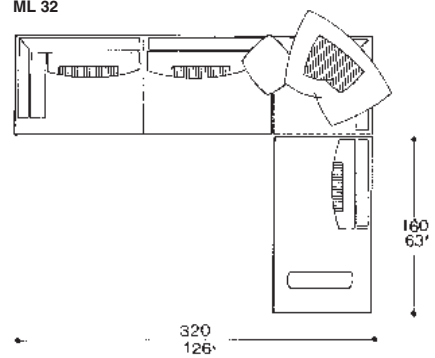

ML 33

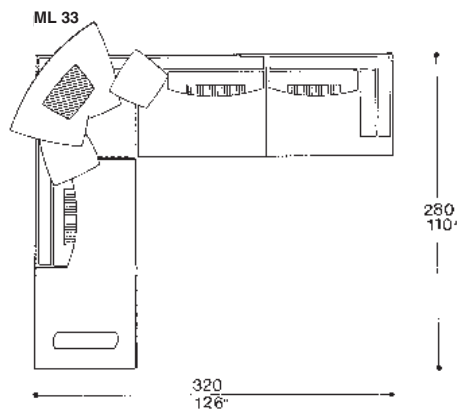

ML 34

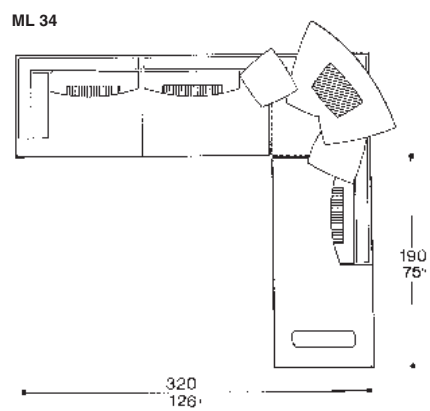

7 ▶

ML 35

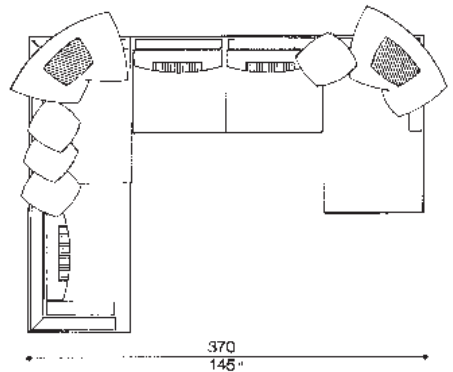

ML 36

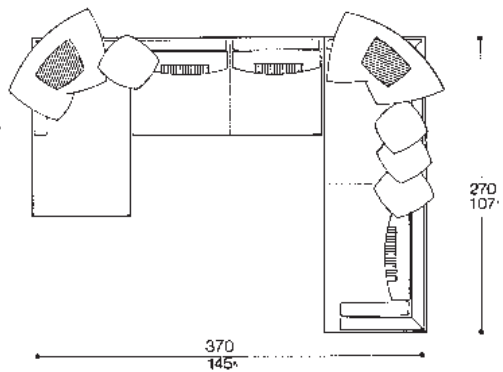

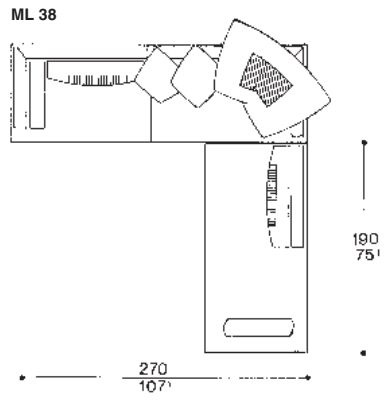
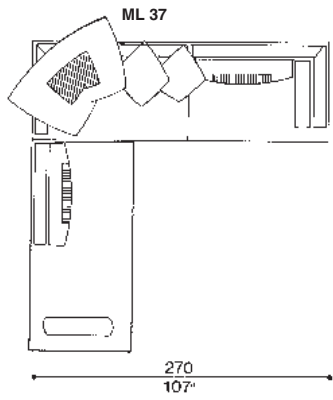

8 ▶

