

OFF

On - Off

ON-OFFDivano trasformabile e componibile
Convertible and modular sofa

ON-OFF rappresenta un insieme di competenze Made in Italy che collaborano per disegnare un progetto organico e completo per arredare ambienti giorno/notte trasformabili.

Il prodotto imbottito di ON-OFF, nasce con l'intento specifico di poter gestire le due componenti principali, mobile e divano, separatamente, lasciando anche in seguito la possibilità di gestire le parti in maniera autonoma.

Il Cliente può decidere di scioglierne la funzione d'insieme a seconda di mutate esigenze, mantenendo comunque la possibilità di utilizzare i due oggetti separatamente nella piena funzione per la quale sono stati acquistati; divano e letto a scomparsa.

Il divano per la propria concezione di modularità, data una struttura base, ha sempre la possibilità di inserire altri elementi per ampliare la composizione d'arredo.

La duttilità del sistema è completata da una serie di prodotti e accessori complementari, che consentono di creare volumi di contenimento anche all'interno delle parti stesse del divano, come il bracciolo e il pouf contenitore per riporre coperte, cuscini, libri o altro. La sedia, la poltroncina da camera e il pouf, a loro volta con contenitore, completano la gamma, utilizzabili come sedute da Home Office con la possibilità di stivare al loro interno quello che normalmente non trova collocazione nei piccoli ambienti (dai giocattoli ai libri di studio alle calzature o alle coperte.)

Nella gamma di accessori sono stati introdotti anche elementi diversi come il bracciolo dalla linea arrotondata per ambienti classici e finiture con profili in rilievo e in contrasto.

La scelta dei rivestimenti è la più completa: dai tessuti classici in misto lino, alle vera pelle passando attraverso a tessuti tecnici e stampati su supporti poliuretanic, che soddisfano tutte le necessità di resistenza al fuoco.



Il divano ON-OFF è caratterizzato da un movimento meccanico, realizzato e brevettato da ATL Group srl, che consente l'avanzamento del cuscino di seduta e contemporaneamente l'inclinazione del cuscino di schienale, fino alla totale posizione orizzontale di quest'ultimo, permettendo l'apertura dell'anta del letto.

Il meccanismo può essere realizzato sia per utilizzo manuale, con un semplice movimento di apertura a scorrimento che consente anche di utilizzare una posizione intermedia di recliner, che con motorizzazione comandata direttamente da un telecomando. Quest'ultima versione consente un posizionamento millimetrico delle varie inclinazioni dello schienale, dando la possibilità di scegliere la personale miglior inclinazione di seduta per il momento che si sta vivendo.



ON-OFF is the expression of the merging of Made in Italy craftsmanship that cooperates, on one hand, to carry out a whole and systematic project; on the other hand, to offer even just one single product to furnish convertible living/sleeping areas.

The end user can decide to separate the two functions, according to different needs and can use the two concepts separately: a freestanding sofa and a folding bed.

The sofa is completely modular and, given a basic structure, it is always possible to add different elements to broaden the furnishing options. This very flexible system is completed by a few more elements and a range of accessories that turn into capacious containers. Even some parts of the sofa, like the armrest and the pouf, hide containers to store blankets, pillows, books or other items.

A chair, a club chair and a pouf, also hiding a container, complete the range, as well as the Home Office seat: they all offer storing possibilities, a precious solution for small environments. Finally, you can store toys, books, shoes, blankets...

Talking about accessories, we have introduced a few more elements, like the round armrest for more traditional environments and pipings, either matching or in contrast.

There is also a vast choice of linings: from classic fabrics in linen-cotton blend to genuine leather, to technical and printed fabrics on polyurethane, compliant with all fire resistance regulations.



The ON-OFF sofa is characterized by an especially designed collapsible mechanism; studied, carried out and patented by ATL Group. It allows the seating cushion to move forward and the back cushion to collapse, until the sofa becomes completely flat, before the bed panel is pulled down.

The mechanism can be manually operated through a sliding system with an intermediate recliner-position, or electrically, through a remote control. The latter allows a variable positioning of both the back and the seat and thus a choice of the best posture for you.

OFF

On - Off

ON-OFF

Divano trasformabile e componibile
Convertible and modular sofa



1
seduta classica
classic seat



2
seduta reclinata
reclined seat



3
seduta stesa
stretched seat



4
contenitore letto aperto
open cabinet

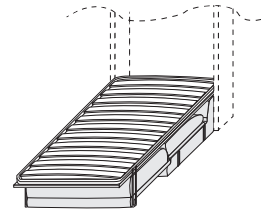
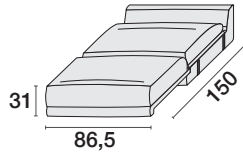
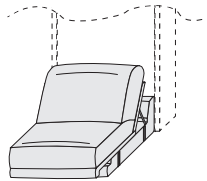
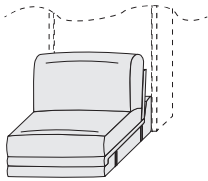

**Poltrona 1 posto
con movimento manuale**
1 seater armchair
with manual recliner

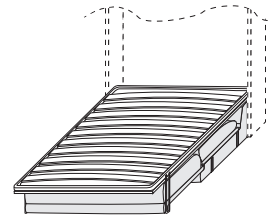
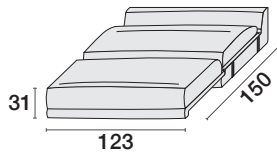
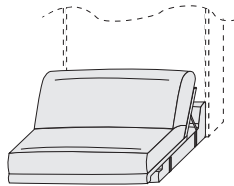
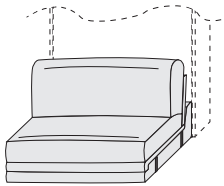

**Divano 1 posto e mezzo
con movimento manuale**
1 and 1/2 seater sofa
with manual recliner

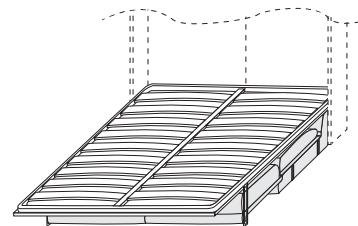
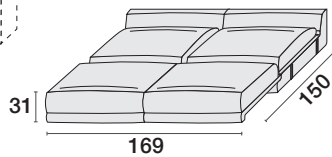
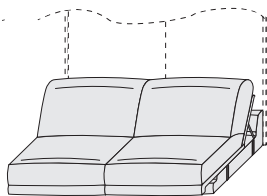
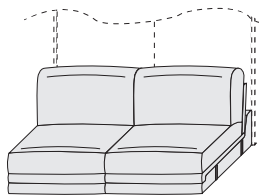

**Divano 2 posti
con movimento manuale**
2 seater sofa
with manual recliner

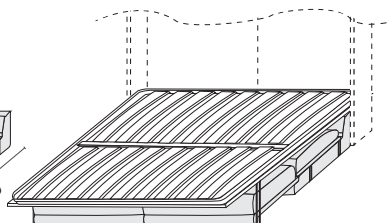
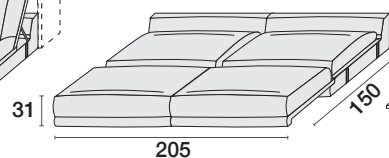
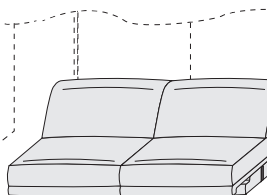
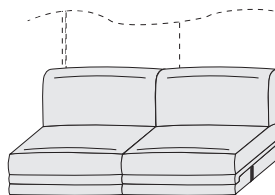

**Divano 2 posti
con movimento manuale**
2 seater sofa
with manual recliner

DIVANI,
POLTRONE, POUF
SOFAS,
ARMCHAIRS, POUF

OFF

On - Off

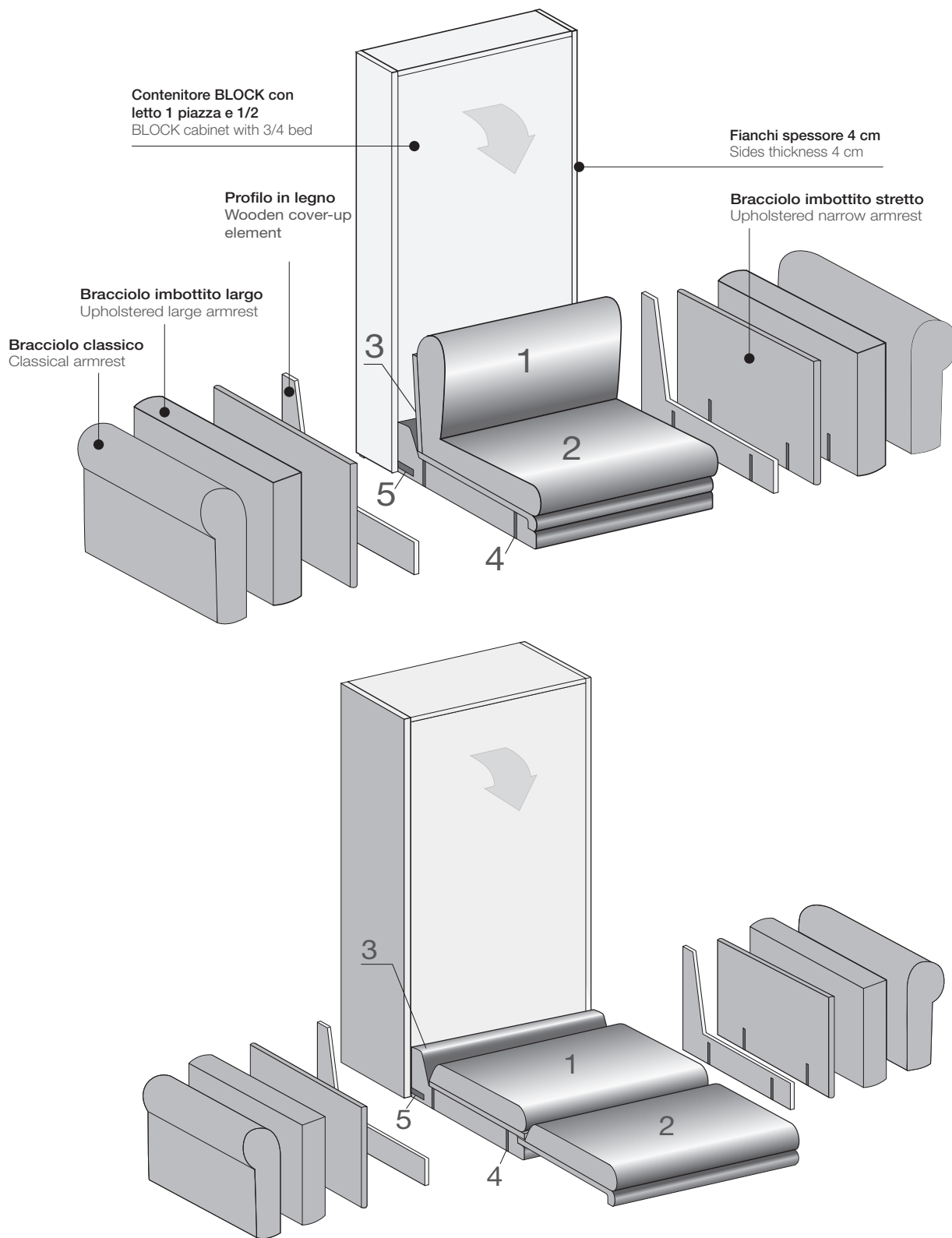
ON-OFFDivano trasformabile e componibile
Convertible and modular sofa**!** **IMPORTANTE** | ATTENTION**IL DIVANO ON - OFF SI ABBINA OBBLIGATORIAMENTE CON CONTENITORE LETTO CON FIANCHI SPESSORE 4 CM.**
ON - OFF SOFA MATCHES EXCLUSIVELY BED CABINET WITH SIDES THICKNESS 4 CM.

OFF

On - Off

ON-OFFDivano trasformabile e componibile
Convertible and modular sofa**Componenti**

Components

- | | | |
|----------|---|---|
| 1 | CUSCINO SCHIENALE BACK CUSHION | Il cuscino schienale è imbottito con piuma naturale e fibre di poliestere e rivestito in tessuto o in pelle. The back cushion is composed by natural feather and polyester fibre and upholstered with fabric or leather. |
| 2 | CUSCINO SEDUTA SEAT CUSHION | Il cuscino seduta è costruito in poliuretano indeformabile di alta qualità, ricoperto da uno strato di ovatta e rivestito in tessuto o in pelle. The seat cushion is made of high quality unshrinkable polyurethane foam covered with a wadding layer and upholstered with fabric or leather. |
| 3 | STRUTTURA STRUCTURE | La struttura è composta da un telaio in ferro e da un meccanismo che permette il livellamento del divano sotto il letto aperto. Ulteriori parti sono realizzate in legno massello o in legno composito da riciclato. The structure is composed by an iron frame and a mechanism which allows the levelling of the same sofa under the open bed. Further parts are realized in solid wood or in composite recycled wood. |
| 4 | SISTEMI DI FISSAGGIO/ COLLEGAMENTO FASTENING/ CONNECTION SYSTEM | I sistemi di aggancio tra laterali sono stati realizzati con un sistema a "baionetta" studiato e rivisto in modo che gli elementi non debbano essere sollevati ma solo avvicinati tra loro. Questo sistema consente al prodotto di essere modulare. The system of connections between lateral modules works through bayonet coupling. This system has been designed and revised so that the elements should not be lifted to be connected but simply pulled together, allowing the product to be modular. |
| 5 | AGGANCIO AL CONTENITORE FIXING TO CABINET | La poltrona e i divani da 1 posto e 1/2 e 2 posti con movimento sono dotati di leva per corretto posizionamento di fronte al mobile contenitore letto. L'elemento divano rimane comunque indipendente rispetto al contenitore letto e libero di posizionarsi secondo le esigenze. 1 seater armchair, 1 and 1/2 seater and 2 seater sofa with recliner are standard supplied with lever for the correct positioning in front of the bed cabinet. The sofa remains in any case freestanding, with regards to the bed cabinet, to allow different positionings. |

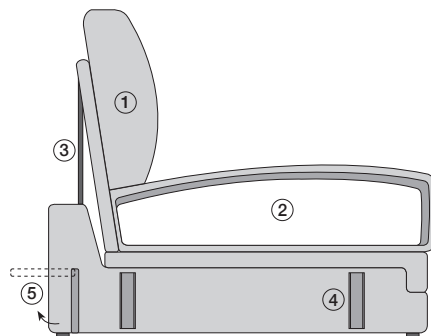
DIVANI,
POLTRONE, POUF
SOFAS,
ARMCHAIRS, POUF**Sistema d'unione**

Joining system

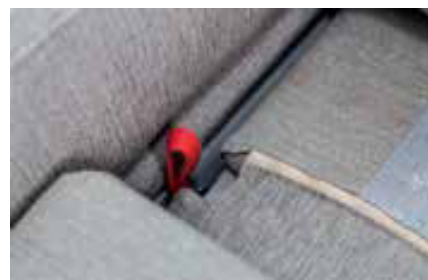
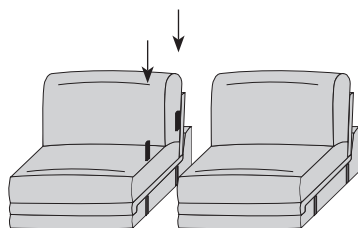
**SISTEMI DI FISSAGGIO COLLEGAMENTO**
FASTENING CONNECTION SYSTEM

I sistemi di aggancio tra i vari moduli che completano la gamma, sono stati appositamente studiati perché siano intuitivi e di facile fruibilità per tutti, senza l'ausilio di alcun utensile. Il sistema classico a "baionetta" è stato rivisto in modo che gli elementi non debbano più essere sollevati per l'aggancio, ma semplicemente avvicinati tra loro e collegati con un apposito innesto a forchetta. Questo sistema consente al prodotto di essere modulare, e quindi di facile trasporto e spostamento, di essere estremamente elastico nel posizionamento degli elementi a terra, CUSTOMIZZABILE, non solo in sede di preventivo, ma anche in seguito a casa del Cliente stesso che con un semplice gesto può trasformare la propria composizione ad esempio da destra a sinistra o invertendo i moduli a piacimento, davvero nello spazio di un secondo ed in estrema sicurezza.

The fastening systems of the seating units are user-friendly and can be used without any tooling. The usual bayonet system has been revised, so that the units do not need to be lifted up to be connected. It is enough to position them close to one another and connect them with a "fork" coupling system. This finding makes the system completely modular and makes shipping easy; one can assemble the sofa in different ways, following their taste and needs. A customizable solution that can be changed both in the quotation phase, as well as at the Customer's home, by changing the combination of the elements at any time, in a second and safely.

BLOCK SYSTEM

Con pochi, semplici gesti la zona giorno diventa una "camera da letto" in piena regola. È l'effetto ON-OFF, un sistema componibile che rivede il concetto di trasformabilità perché considera un nuovo modo di utilizzare lo spazio domestico. Il classico divano trasformabile, sempre un po' scomodo in quanto compromesso tra i due, lascia il posto ad un'idea sorprendentemente efficace e semplice, come accendere la luce.

In a few simple steps the living area turns into an actual bedroom. It's the "ON-OFF effect": a step change in convertible solutions, with a modular system that radically changes the residential landscape. A real freestanding sofa and a real, comfortable bed. Don't give up on comfort. Don't give up on style. As easy as turning the light on.

RETE VERTICALE VERTICAL FRAME



RETE ORIZZONTALE HORIZONTAL FRAME



FOCUS

Con un facile gesto, l'apposita maniglia sotto al cuscino di seduta consente di modificare la vostra posizione sul divano o di completare l'apertura dello stesso per permettere l'utilizzo del letto.

By simply pulling a handle underneath the seat cushion, you can slightly recline the seat or complete the full opening of the sofa to allow the bed panel to come down.



Rivestimento rete in tessuto, color grigio o corda.

Fabric covering for slatted frame, grigio or corda colour.



BLOCK SYSTEM

P / D 33,4 cm / H 229 - 261cm

Block letto matrimoniale verticale
Block vertical double bed
* L / W 169,6 cm H 229 / 261 cm P / D 33,4 cm

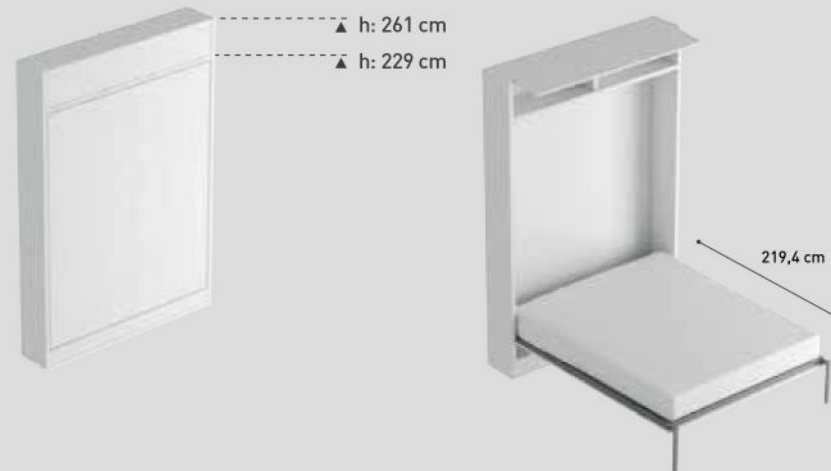

Block letto singolo verticale e piazza e mezzo
Block vertical single bed and 3/4 bed
* L / W 88 / 124,6 cm H 229 / 261 cm P / D 33,4cm



P / D 46,2 - 59 cm / H 229 - 261 cm

Block letto matrimoniale verticale
Block vertical double bed
* L / W 169,6 cm H 229 / 261 cm P / D 46,2 / 59 cm

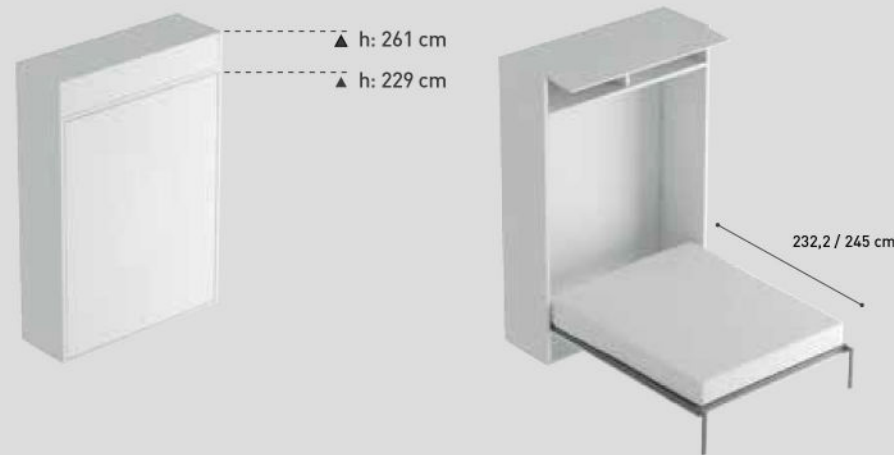

Block letto singolo verticale e piazza e mezzo
Block vertical single bed and 3/4 bed
* L / W 88 / 124,6 cm H 229 / 261 cm P / D 46,2 / 59cm



Materasso Mattress
MATRIMONIALE DOUBLE L / W 155 / 160 cm A / H 16 / 20 cm P / D 195 / 200 cm
PIAZZA E MEZZO 3/4 BED L / W 115 cm A / H 16 / 20 cm P / D 195 cm
SINGOLO SINGLE L / W 80 cm A / H 16 / 20 cm P / D 195 cm

* Per tutte le misure in larghezza aggiungere spessore dei fianchi.
For all width sizes, please, add the sides thickness.

P / D 33,4 cm / H 197 - 229 - 261cm

Block letto matrimoniale orizzontale
Block horizontal double bed
* L / W 205,6 cm H 197 / 229 / 261 cm P / D 33,4 cm

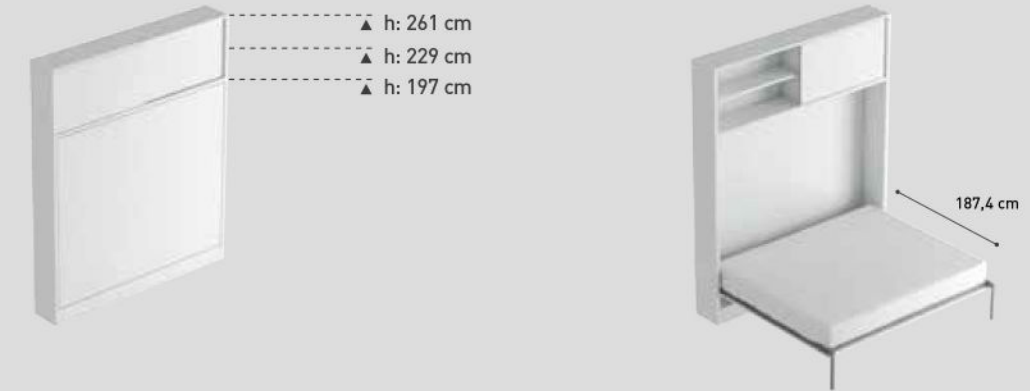

P / D 46,2 - 59 cm / H 197 - 229 - 261cm

Block letto matrimoniale orizzontale
Block horizontal double bed
L / W 205,6 cm H 197 / 229 / 261 cm P / D 46,2 / 59 cm

Testata opzionale
Optional headboard



P / D 33,4 - 46,2 - 59 cm / H 103,8 - 135,8 cm

Block orizzontale letto singolo e piazza e mezzo
Block horizontal single and 3/4 bed
L / W 205,6 cm H 103,8 / 135,8 cm P / D 33,4 / 46,2 / 59cm

Testata opzionale
Optional headboard

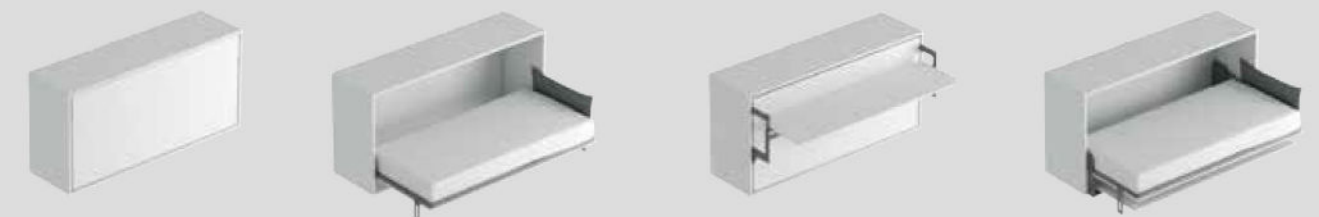

Materasso Mattress
MATRIMONIALE DOUBLE L / W 195 / 200 cm A / H 16 / 20 cm P / D 165 / 170 cm
PIAZZA E MEZZO 3/4 BED L / W 195 cm A / H 16 / 20 cm P / D 110 / 115 cm
SINGOLO SINGLE L / W 195 cm A / H 16 / 20 cm P / D 80 / 85 cm

Ingombro da aperto Size when open
108 cm (min) / 165,6 cm (max)

ON-OFF SOFA

Suggerimenti di divani con sistema *recliner* da utilizzare con i letti a ribalta matrimoniali.
A few suggestions of sofas with *recliner* system, to be matched with folding beds.



...e altri con divani fissi da collocare in libertà in qualsiasi spazio.
...and other sectional sofas to be used as regular sofas in any environment.



ON-OFF SOFA

BRACCIOLI
ARMRESTS

BRACCIOLO CLASSICO
CLASSICAL ARMREST



BRACCIOLO LARGO
LARGE ARMREST



BRACCIOLO STRETTO
NARROW ARMREST



PROFILO IN LEGNO
WOODEN COVER-UP ELEMENT



BRACCIOLO LARGO CON CONTENITORE
FLIP-UP LARGE ARMREST



SOUND BRACCIOLO
SOUND ARMREST

Il progetto ON-OFF è stato completato con alcuni elementi componibili, che racchiudono una serie di pratici e utilissimi vani, o elementi funzionali aggiuntivi che possono essere richiesti come optional.

ON-OFF features are completed by a few modular elements, that hide an array of practical and useful containers, or further functional additions upon request.



Il bracciolo largo viene corredato da un vano interno, dove possono venire riposti i guanciali del letto, o ciò che più si desidera. A ulteriore completamento, nel suo vano interno può trovare alloggio anche un tavolino accessorio, che, inserito nell'apposita guida, funge come pratico piano di appoggio per lavoro, lettura o qualsiasi necessità.

The large armrest is in fact a container, that can lodge pillows or any other item. A lift-up tablet is a further completing element: once inserted in the runner, it works as a small workstation or reading top, or anything else.



Con l'idea di creare spazio ulteriore all'interno della propria abitazione, il pouf fisso, già presente nell'insieme degli elementi componibili, si può trasformare in un altro comodo contenitore per coperte, guanciali, libri, etc...

To further enhance the space optimization, the most traditional pouf, can become, once again, a useful container for blankets, pillows, books, etc...



ELEMENTI RECLINABILI
RECLINING ELEMENTS

Poltrona 1 posto
1 seater armchair



Divano 1 posto e mezzo
1 and 1/2 seater sofa



Divano 2 posti
2 seater sofa

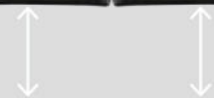

ELEMENTI FISSI COMPONIBILI IN AUTONOMIA DAL MOBILE
MODULAR FREESTANDING ELEMENTS

Seduta fissa
Fixed unit



Chaise longue
Chaise longue



Elemento angolare
Corner unit



Serie di pouf in varie dimensioni fissi o apribili
Fixed or flip-up pouf in different sizes

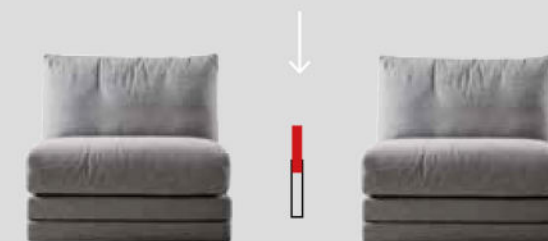

Gli elementi di giunzione tra i vari componenti del divano sono facilmente posizionabili e riposizionabili, consentendo anche ai non addetti ai lavori di poter modificare l'aspetto e la forma del proprio divano garantendo sempre una eccezionale stabilità.

The connecting elements between the various components of the sofa are easy to be positioned, allowing even laymen to change the aspect and the shape of the sofa always guaranteeing exceptional stability.



Posteriormente agli elementi con movimento, si trova un'asta mobile che rappresenta l'unico vincolo fra divano e mobile letto. Inserendo l'asta fra spalla e anta (senza nessun fissaggio) si consente al divano di rimanere sempre perfettamente allineato rispetto alla discesa del letto. Con l'asta abbassata, nascosta fra un elemento e l'altro, il divano torna a vivere in completa autonomia, separato dal mobile.

Behind the elements with reclining mechanism there is a collapsible lever. This represents the only connection between the sofa and the bed block. Once you position the lever parallel to the floor, it sticks out of the back of the sofa to be inserted, without any fixing, in the slot between the side and the door of the bed container. This system allows the sofa to always stay perfectly aligned with the bed structure, thus avoiding misplacements that would preclude a normal functioning of the mechanism. By collapsing the bar, the sofa gets back to being a totally freestanding element.

SISTEMA RECLINER

RECLINER SYSTEM

Il divano ON-OFF è caratterizzato da un movimento meccanico nato appositamente per lui; studiato, realizzato e brevettato da ATL Group spa, consente l'avanzamento del cuscino di seduta e contemporaneamente l'inclinazione del cuscino di schienale, fino alla totale posizione orizzontale di quest'ultimo. Il meccanismo così costituito, una volta aperto completamente, offre la possibilità di discesa del Letto. Il meccanismo può essere realizzato sia per utilizzo manuale, con un semplice movimento di apertura a scorrimento che consente anche di utilizzare una posizione intermedia di recliner, che con motorizzazione comandata direttamente da un telecomando. Quest'ultima versione consente un posizionamento millimetrico delle varie inclinazioni dello schienale, dando la possibilità di scegliere la personale miglior inclinazione di seduta per il momento che si sta vivendo.

Esistono diversi tipi di apertura e chiusura con il sistema motorizzato:

- apertura/chiusura solo delle sedute divano
- apertura /chiusura solo del contenitore letto
- apertura /chiusura combinata del divano e contenitore letto contemporaneamente

Anche con movimento motorizzato.

Sistema coperto da brevetto internazionale.

The ON-OFF sofa is characterized by an especially designed collapsible mechanism; studied, carried out and patented by ATL Group. It allows the seating cushion to move forward and the back cushion to collapse, until the sofa becomes completely flat, before the bed panel is pulled down. The mechanism can be manually operated through a sliding system with an intermediate recliner-position, or electrically, through a remote control. The latter allows a variable positioning of both the back and the seat and thus a choice of the best posture for you.

There are different kinds of opening/closing with the remote control:

- opening/closing of the sofa seats only
- opening/closing of the bed cabinet only
- combi opening/closing of both sofa and bed cabinet together

Also with remote control electro-mechanism. System covered by international patent.



SISTEMA MOTORIZZATO COMBI

COMBI MOTOR SYSTEM



Apertura/chiusura seduta sinistra divano
Opening/closing left seat of the sofa



Apertura/chiusura seduta destra divano
Opening/closing right seat of the sofa



Apertura combinata letto/divano
Combi opening of both bed and sofa



Chiusura combinata letto/divano
Combi closing of both bed and sofa