

# LD02 - DALIA LETTO

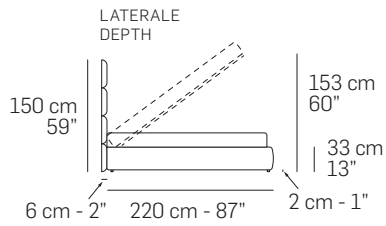

**7907 - KING SIZE**  
**7917 - 1 MOV - KING SIZE**

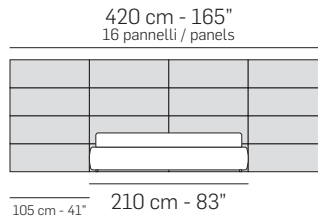

MAT.  
193x203 cm  
76x80"

**7507 - QUEEN SIZE**  
**7517 - 1 MOV - QUEEN SIZE**

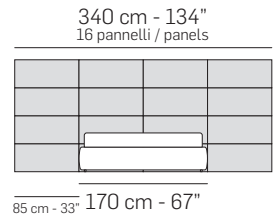

MAT.  
153x203 cm  
60x80"

**G7907 - KING SIZE**  
**G7917 - 1 MOV - KING SIZE**

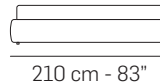

MAT.  
193x203 cm  
76x80"

**G7507 - QUEEN SIZE**  
**G7517 - 1 MOV - QUEEN SIZE**

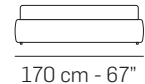

MAT.  
153x203 cm  
60x80"

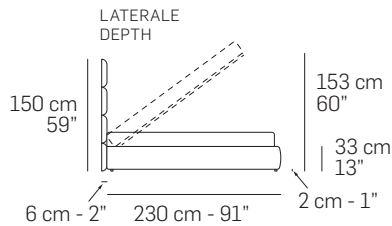

**7707 - CALIFORNIA KING**  
**7717 - 1 MOV - CALIFORNIA KING**

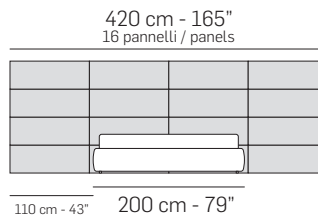

MAT.  
183x213 cm  
72x84"

**G7707 - CALIFORNIA KING**  
**G7717 - 1 MOV - CALIFORNIA KING**

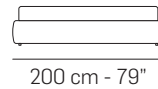

MAT.  
183x213 cm  
72x84"

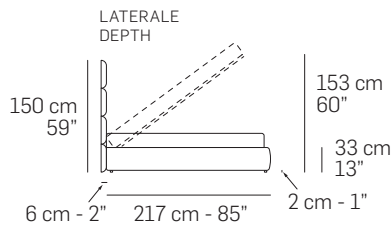

**7807**  
**7817 - 1 MOV**

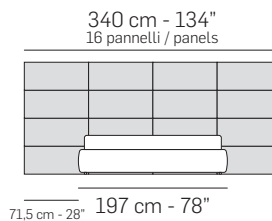

MAT.  
180x200 cm  
71x79"

**7657**  
**7667 - 1 MOV**

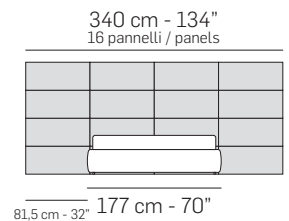

MAT.  
160x200 cm  
63x79"

**G7807**  
**G7817 - 1 MOV**

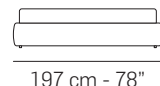

MAT.  
180x200 cm  
71x79"

**G7657**  
**G7667 - 1 MOV**

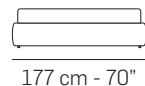

MAT.  
160x200 cm  
63x79"

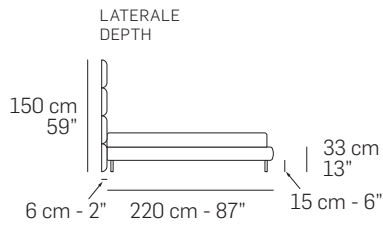

**7067 - KING SIZE**

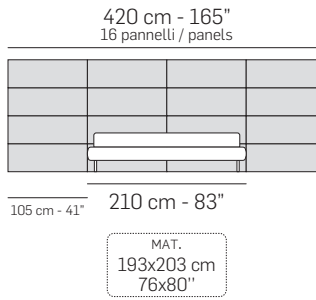

**7068 - QUEEN SIZE**

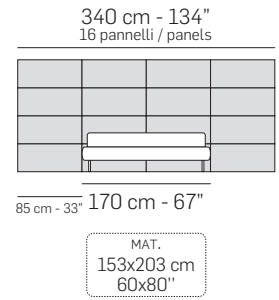

**G7067 - KING SIZE**

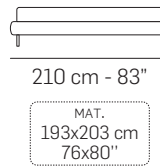

**G7068 - QUEEN SIZE**

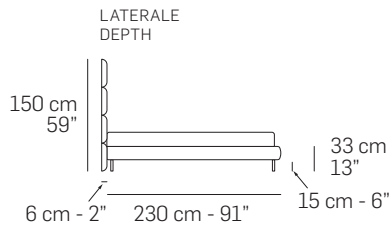
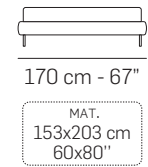

**7069 - CALIFORNIA KING**

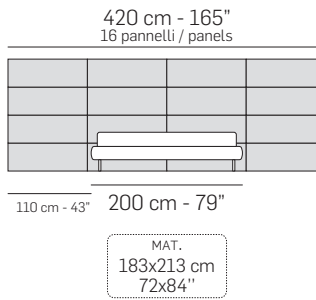

**G7069 - CALIFORNIA KING**

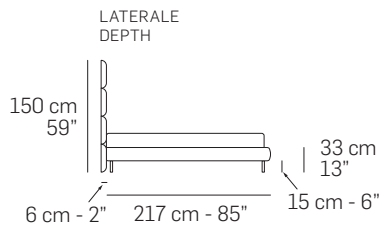
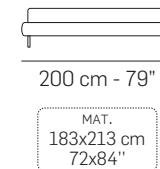

**7057**

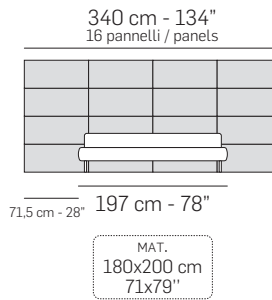

**7047**

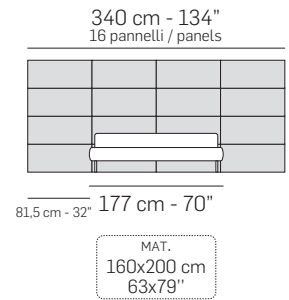

**G7057**

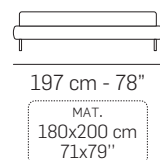

**G7047**

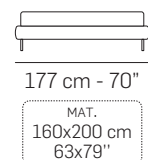

SCHEMA MONTAGGIO PANNELLI CONSIGLIATO / RECOMMENDED ASSEMBLY SCHEME FOR PANELS



N.B. Solo per rivestimento in pelle si consiglia di montare i pannelli con le cuciture alternate con il taglio a destra (A) o a sinistra (B) al fine di evitare il disallineamento tra le cuciture (vedi fig.1).

N.B. For leather covering, it is recommended to install the panels with alternating stitches with the cut to the right (A) or left (B), to avoid misalignment between stitches (see fig.1)

PANNELLI TESTIERA / HEADBOARD PANELS

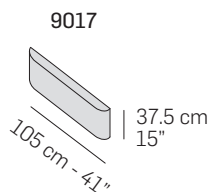

fig.2 / pic.2



N.B. Solo per rivestimento in pelle specificare se prevedere il taglio a destra (A) o a sinistra (B) (vedi fig.2). Per ogni pannello aggiuntivo si consiglia di rispettare lo schema in basso al fine di evitare il disallineamento tra le cuciture (vedi fig.3).

N.B. For leather covering, specify whether to cut to the right (A) or left (B) (see fig.2). For each additional panel, it is advised to follow the scheme below to avoid misalignment between stitches (see fig.3).

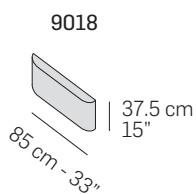
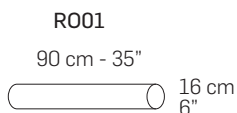

fig.3 / pic.3



ACCESSORI LETTO / BED ACCESSORIES

RULLI SOTTOGUANCIALE CONSIGLIATI / RECOMMENDED ROLL CUSHIONS



Versioni consigliate / Suggested versions:  
7907 - 7917 - 7707  
7717 - 7807 - 7817  
7067 - 7069 - 7057  
G7907 - G7917 - G7707  
G7717 - G7807 - G7817  
G7067 - G7069 - G7057

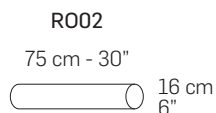

Versioni consigliate / Suggested versions:  
7507 - 7517 - 7068  
7657 - 7667 - 7047  
G7507 - G7517 - G7068  
G7657 - G7667 - G7047