

ARKETIPO / DIVANI-EN

STARMAN

designed by Ludovica + Roberto Palomba 2019



STRUCTURE: wood.

FRAME UPHOLSTERY: multi-density expanded polyurethane (D40P + OS35S).

SEAT UPHOLSTERY: multi-density expanded polyurethane (D40P + OS37S + 35EM + Mind Foam) covered with synthetic lining 230gr.

BACK CUSHION UPHOLSTERY: multi-density expanded polyurethane (2IM + D50 Mind Foam) covered with synthetic lining 380gr.

SEAT HEIGHT: 42 cm - 45 cm with feet h. 8 cm.

ARM HEIGHT: 65 cm

FEET: plastic, h. 5 cm.

On request feet can be supplied 8 cm high without extra-charge.

The units marked with * have a short arm.

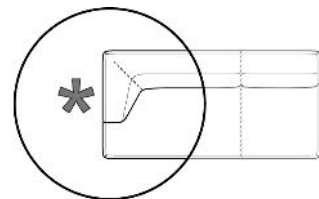

Sofa

Right or left unit with angle 30°

Sofa - DEPTH 112 CM

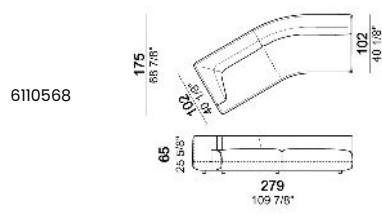
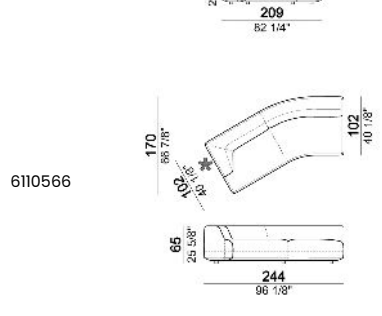
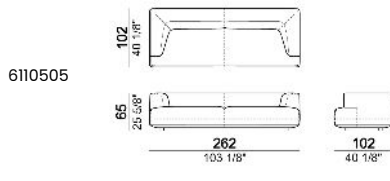
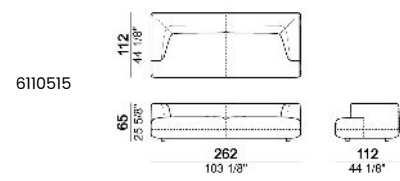
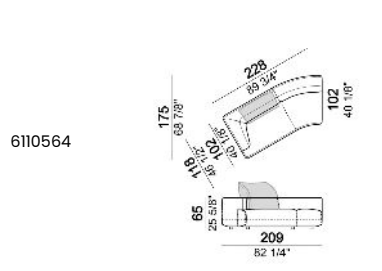
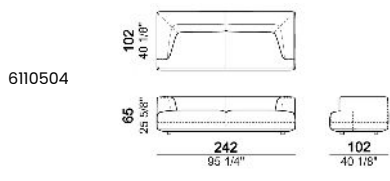
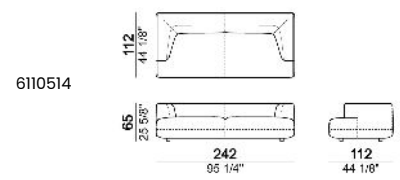
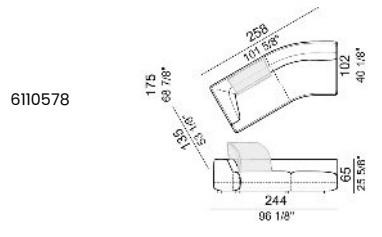
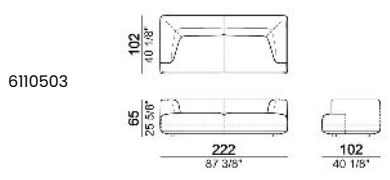

Right or left unit

Right or left unit with right or left pouf

Right or left unit with right or left pouf and angle 30°

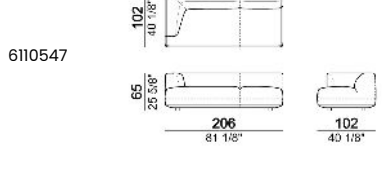
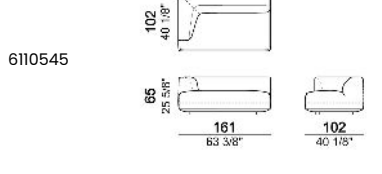
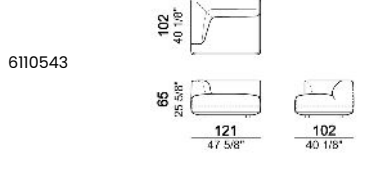
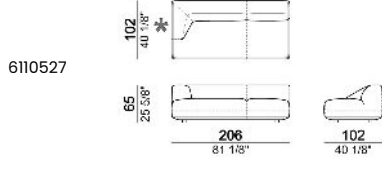
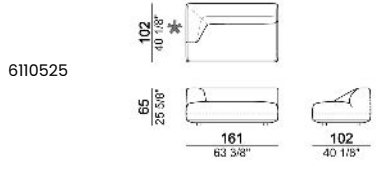
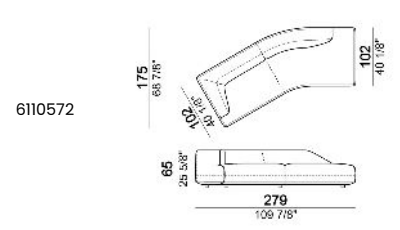
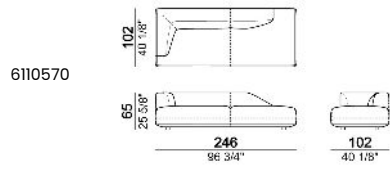
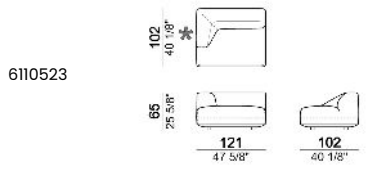

Right or left corner unit

6110562

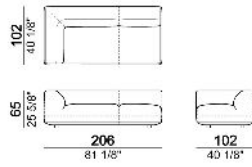

Central unit

6110520

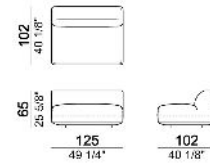

Central unit with right or left pouf

6110556

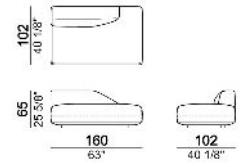

6110521

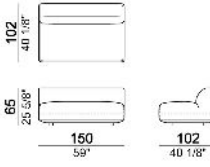

6110558

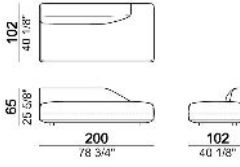

6110522

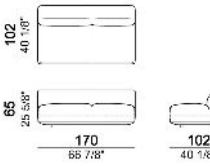

Central unit with right or left pouf and angle 30°

6110560

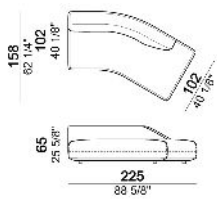

Chaise-longue with right or left short arm

6110534

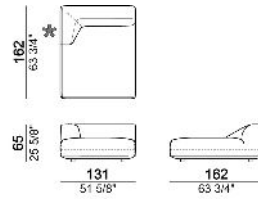

Corner

6110555

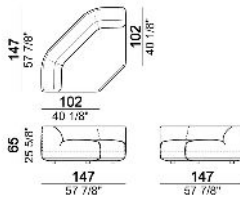

6110536

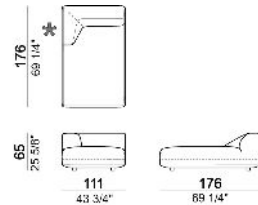

Right or left corner with angle 45°

6110574

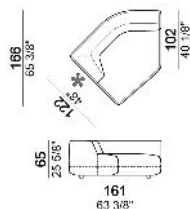

Unit with right or left pouf and angle 45°

6110576

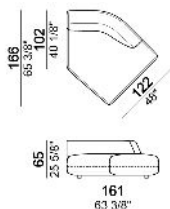

Pouf

6110550

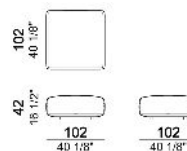

6110551

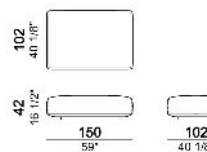

Back cushion.

7110561

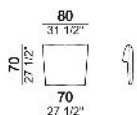

Composition "A" (left unit 206 cm, chaise-longue with right short arm 131x162 cm + 2 back cushions).

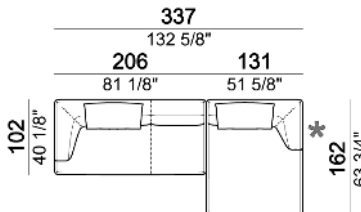

Composition "B" (left unit 161 cm, left corner unit 206 cm, right unit 121 cm + 3 back cushions).

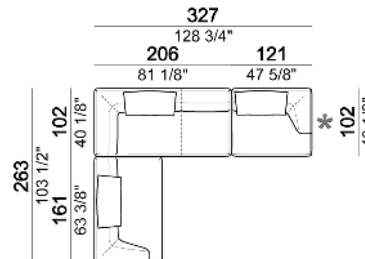

Composition "C" (left unit 206 cm, right unit 161x166 cm angle 45° + 2 back cushions).

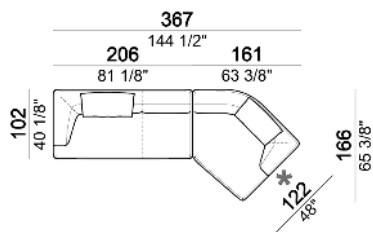

Composition "D" (left unit 161 cm, corner 147x147 cm, central unit 225 cm with right pouf and angle 30° + 3 back cushions).

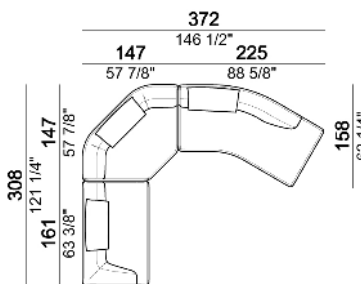

Composition 'E' (left unit 206 cm + corner 147x147 cm + central unit 200 cm with right pouf + 4 back cushions 80x70 cm)

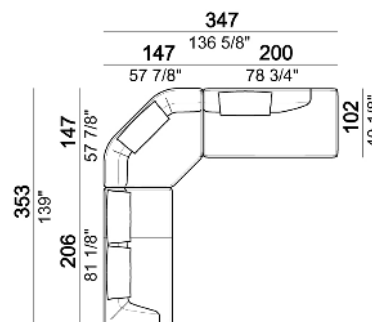

Composition "F" (left unit 244x175 cm
with angle 30°, right unit 161x166 cm
angle 45° + 2 back cushions).

