











Anderson

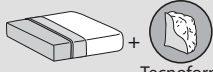

	Seduta - Seat	Schienali - Backrests	Struttura - Structure	
Rivestimento Upholstering (8)	Sfoderabile Removable   	 	 	
	Non sfoderabile Not removable -			
Imbottiture Padding (5-6-3)	 D.30kg/m³	 D.18kg/m³	 Tecnoform	

INFORMAZIONI TECNICHE

Struttura: 1

Masselli portanti in legno di abete. Elementi strutturali in pannelli di legno multistrati in classe E1, tamponamenti in faesite.

Molleggio: 1-4

Schienale in pannello di faesite. Seduta in nastri elastici di fibra propilenica e lattice incrociati e meccanicamente pretensionati.

Note:

Meccanismo del poggiatesta regolabile in 6 posizioni con movimento manuale, in acciaio cromato. (2)

TECHNICAL INFORMATION

Structure: 1

Solid fir wood. Structural elements in multilayer wood panels in class E1, infills in faesite.

Springing: 1-4

The back is made of hardboard panels. Seat with pre-tensioned crossed propylene fibre and latex elastic webbing.

Note:

Chromed steel headrest mechanism 6 positions adjustable with manual mechanism (2).

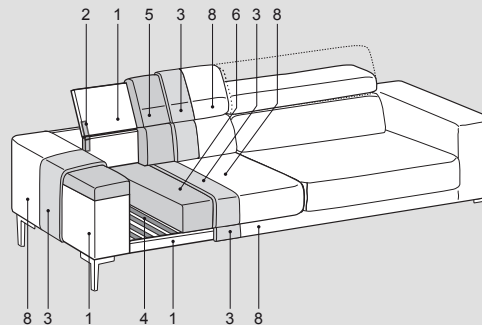
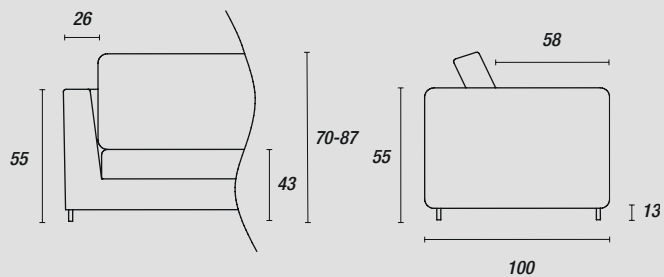

Piedini - Feet:

di serie

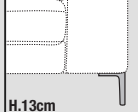

Cromo lucido (ME04)

optional Drink

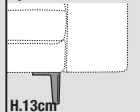

con maggiorazione Cromo nero (ME05)