

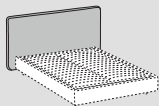

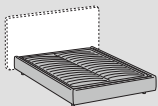







Pacific

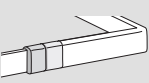

	 Testiera - Headboard	 Giroletto - Bed frame		
Rivestimento Upholstering (8)	Sfoderabile / Removable   	Sfoderabile / Removable   		
	Non sfoderabile / Not removable —	Non sfoderabile / Not removable —		
Imbottiture Padding (5-6-7)	 +  D.21-30-40kg/m ³	 +  D.30kg/m ³		

INFORMAZIONI TECNICHE

Struttura: (1-2-3-4)

Testiera in pannelli di legno multistrato in classe E1, legno di abete e pannelli di faesite; longoni e pediera in pannelli di particelle di legno (MDF) in classe E1, pannelli di osb, legno di abete e pannelli di faesite.

Note:

Possibilita' di regolare l'altezza della rete su cui appoggia il materasso nei letti fissi privi di meccanismo.

Caratteristiche relative ai materiali utilizzati descritte nella sezione tecnica a fine listino. Set biancheria da letto e coprirete disponibili nella sezione accessori per letti.

TECHNICAL INFORMATION

Structure: (1-2-3-4)

Headboard made of class E1 multilayer wood, fir wood and faesite panels; side rails and footboard made of class E1 particle board (MDF), osb panels, fir wood and faesite panels.

Note:

Height-adjustment option for the bedbase that supports the mattress, allowing total or partial integration for beds without mechanism.

For characteristics of the used materials, see the technical section.

Bed linen and bed-base cover set available in the section "Bed accessories"

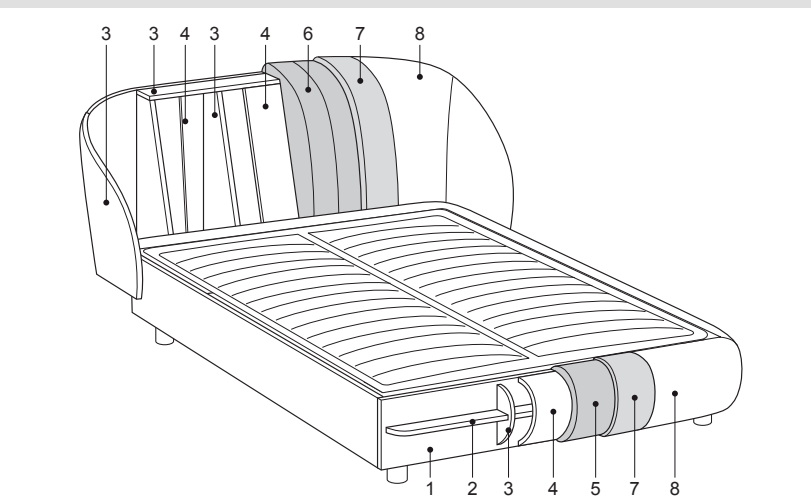

Versioni disponibili (per dimensioni selezionate)

Available versions (by selected dimensions)

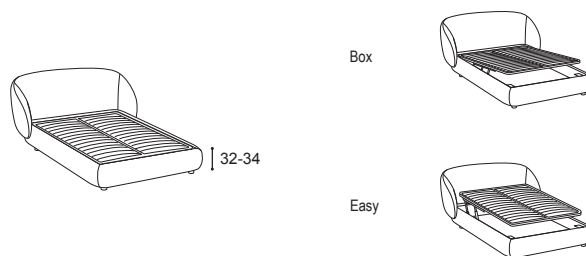







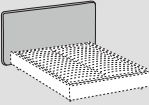
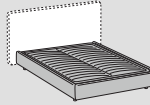

Disponibile per materasso da:
Available for mattress:



Pacific mix

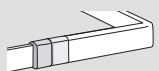

	 Testiera - Headboard	 Giroletto - Bed frame	
Rivestimento Upholstering (8)	Sfoderabile Removable  		
	Non sfoderabile Not removable -	-	
Imbottiture Padding (5-6-7)	 +  D.21-30-40kg/m ³	 +  D.30kg/m ³	

INFORMAZIONI TECNICHE

Struttura: (1-2-3-4)

Testiera in pannelli di legno multistrato in classe E1, legno di abete e pannelli di faesite; longoni e pediera in pannelli di particelle di legno (MDF) in classe E1, pannelli di osb, legno di abete e pannelli di faesite.

Note:

Possibilita' di regolare l'altezza della rete su cui appoggia il materasso nei letti fissi privi di meccanismo.

Caratteristiche relative ai materiali utilizzati descritte nella sezione tecnica a fine listino. Set biancheria da letto e coprirete disponibili nella sezione accessori per letti.

TECHNICAL INFORMATION

Structure: (1-2-3-4)

Headboard made of class E1 multilayer wood, fir wood and faesite panels; side rails and footboard made of class E1 particle board (MDF), osb panels, fir wood and faesite panels.

Note:

Height-adjustment option for the bedbase that supports the mattress, allowing total or partial integration for beds without mechanism.

For characteristics of the used materials, see the technical section.

Bed linen and bed-base cover set available in the section "Bed accessories"

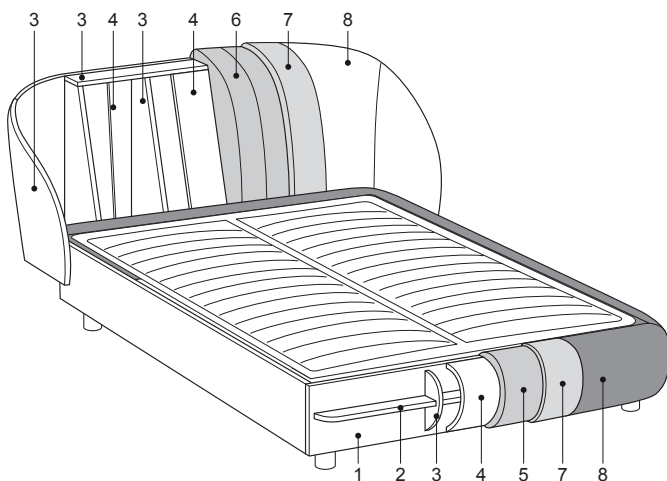

Versioni disponibili (per dimensioni selezionate)

Available versions (by selected dimensions)

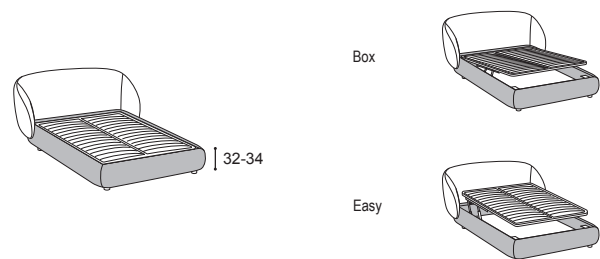

Disponibile per materasso da:
Available for mattress:

