

SOVET

ITALIA



Slim

collection booklet

collection
booklet

Slim madia

“
**A natural evolution that completes
the collection. The rounded edges
of the wooden elements perfectly
merge with the aluminium structure.
The different finishes of the top
create original solutions
and contrasts.**

Una naturale evoluzione che
completa la collezione. Gli spigoli
arrotondati dei moduli in legno
si fondono perfettamente con la
struttura in alluminio. Le varie finiture
del piano creano inedite
soluzioni e contrasti.

”

Through a path of material deconstruction, I have obtained essential and minimal lines able to create a versatile structure, that can be integrated in different interior spaces regardless of their styles. This is the Slim concept, a versatile and at the same time multifunctional collection thanks to the various solutions offered. From tables, coffee tables and consoles to the sofa and the upholstered benches. The collaboration with Sovet allowed me to express the project the best way possible, using the aluminum to create the Slim structure with an engineering and technological precision, thanks to the company know-how in the furnishing design. The dialogue led us to the creation of an icon of the brand, recognizable in both domestic and contract projects all over the world.

Attraverso un percorso di destrutturazione della materia sono giunto a ricavare delle linee essenziali e minimali che permettessero di creare una struttura versatile e che si integrassero negli interni aldilà dello stile di questi. Questo è il concept di Slim, una collezione versatile ed allo stesso tempo multifunzione grazie alle varie soluzioni proposte. Dai tavoli, tavolini e console fino ad arrivare al divano e alle sedute. La collaborazione con Sovet mi ha permesso di esprimere al meglio il progetto, realizzando la struttura Slim in alluminio con precisione ingegneristica e tecnologica che fonda le radici nel Know-how aziendale nella progettazione d'arredo. Il dialogo ha portato alla creazione di un'icona del brand, riconoscibile in spazi abitativi e progetti in tutto il mondo.

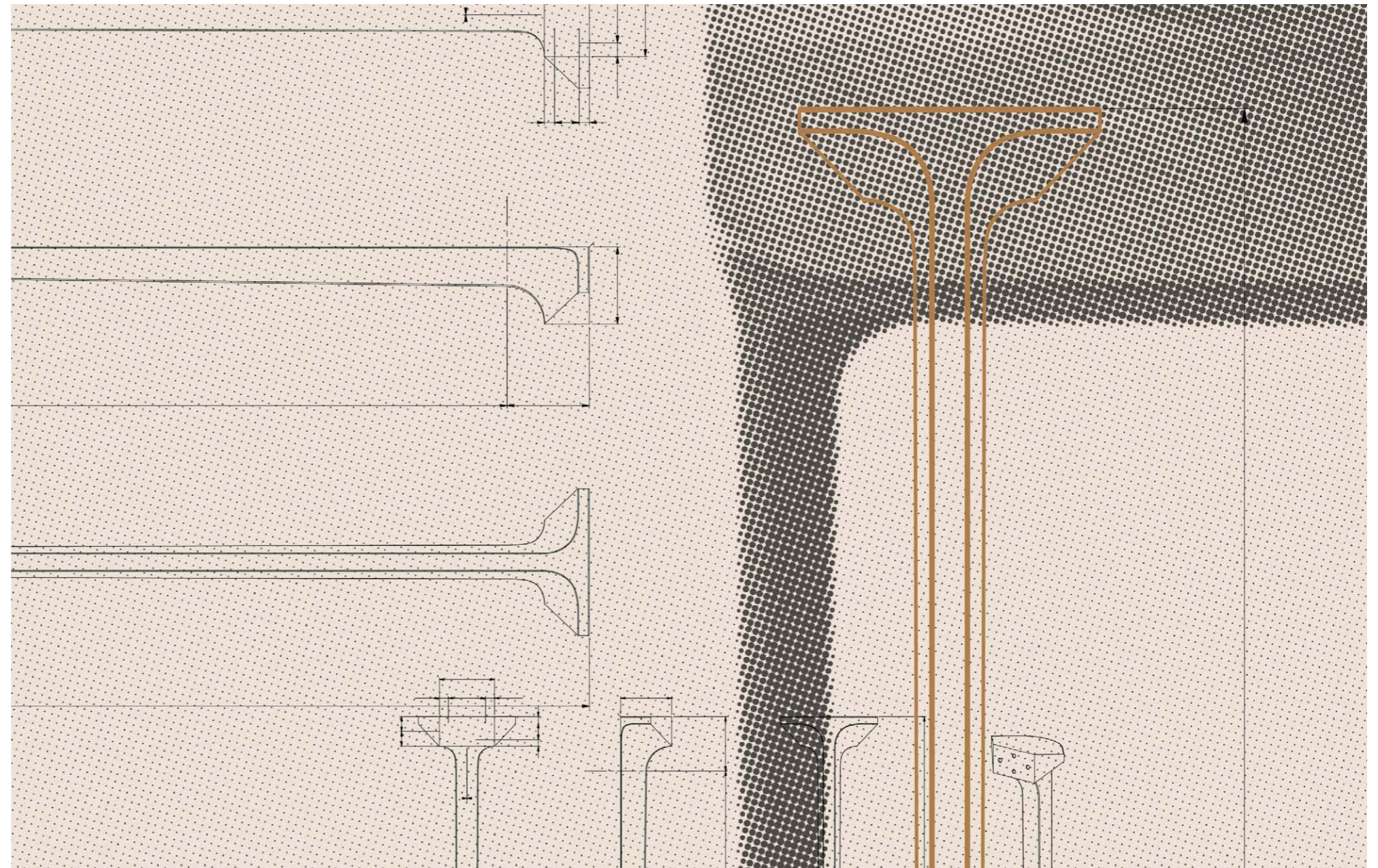

Models & Dimensions

Sideboard with aluminium structure and legs, various finishes. Elements in mdf veneered, Canaletto walnut or oak stained wengé. Top available in different materials and finishes. Height-adjustable smoked glass internal shelf.

Madia con struttura e gambe in alluminio, varie finiture. Moduli in mdf impiallacciato Noce Canaletto o rovere tinto wengé. Piano disponibile in vari materiali e finiture. Ripiano centrale in vetro fumé regolabile in altezza.

Slim madia h88

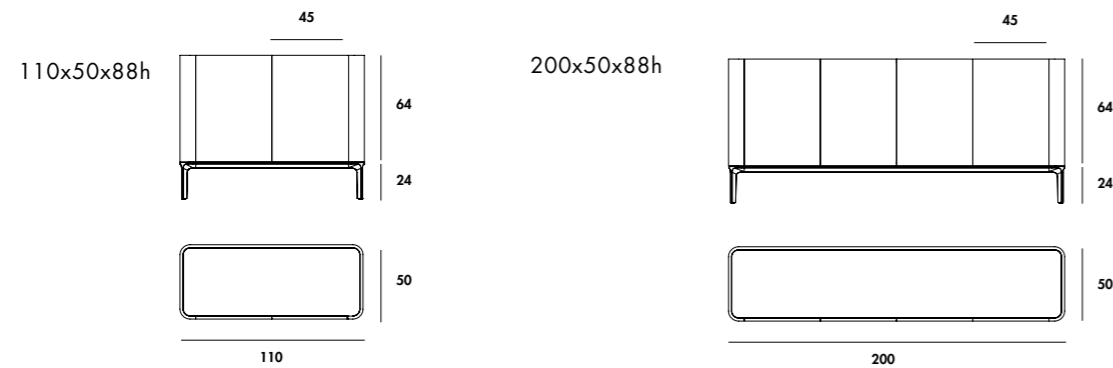

Slim madia h101

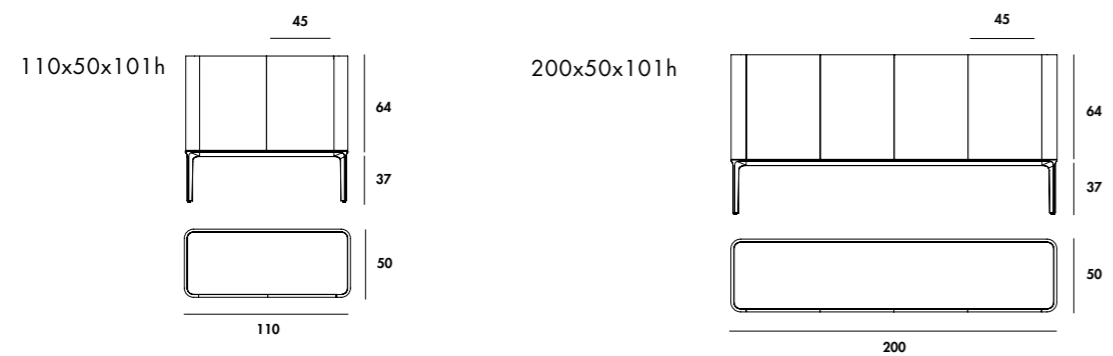

Slim madia h110

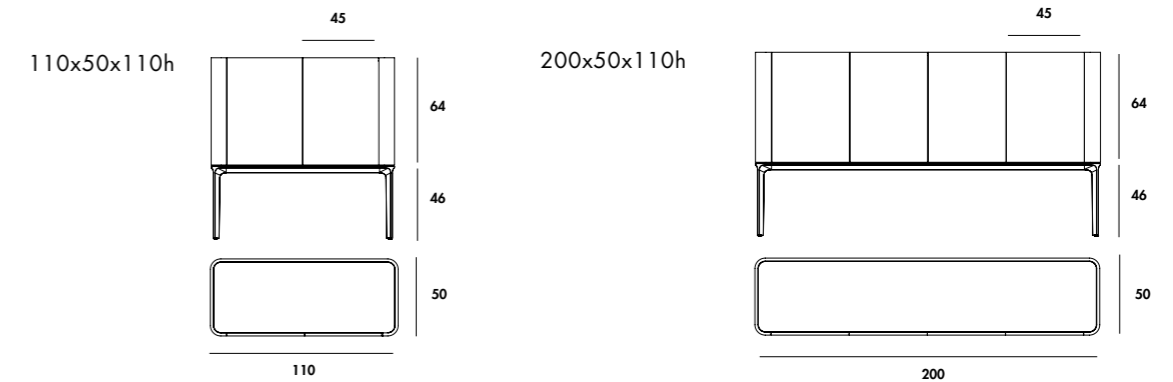

Slim madia h138

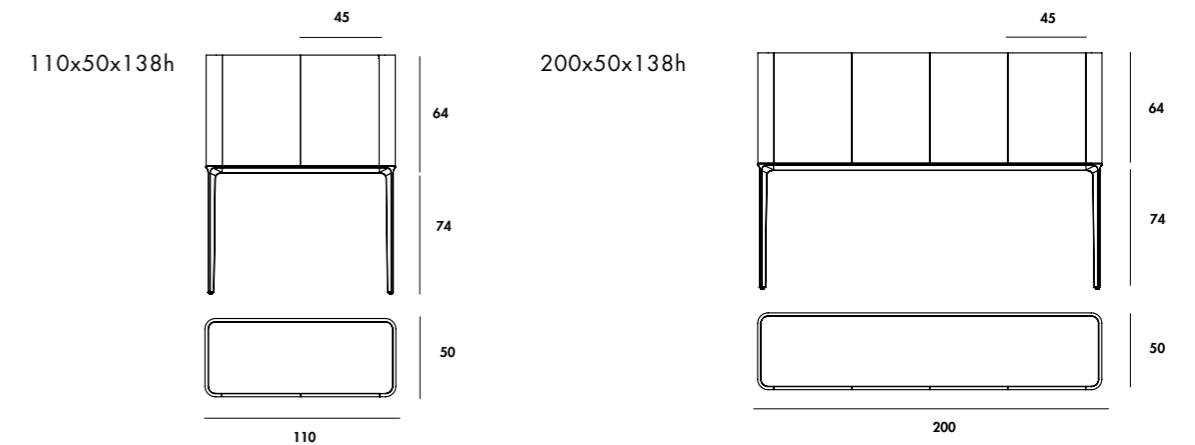

misure modulo/
element measures

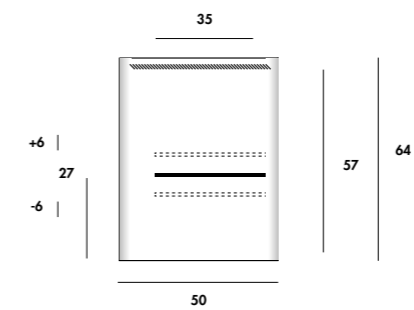

collection
finishes



top

Net glass



NEB1
White Net glass
Net glass bianco



NEC1
Mocha Net glass
Net glass caffè

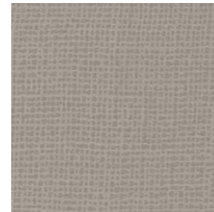

NEC2
Clay Net glass
Net glass creta



NEC3
Cement Net glass
Net glass col. cemento



NER4
Rust Net glass
Net glass col. ruggine



NEV2
Moss green Net glass
Net glass col. muschio

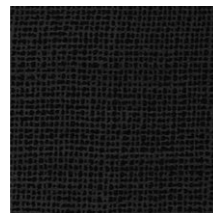

NEN1
Black Net glass
Net glass nero



NEM6
Tobacco
Net glass
Net glass col. tabacco



NES1
Champagne
Net glass
Net glass champagne

Ceramic Ceramica Categoria CE1

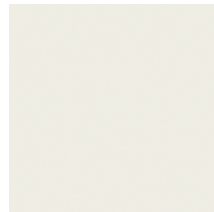

CT
Ceramic titanio
Ceramica titanio

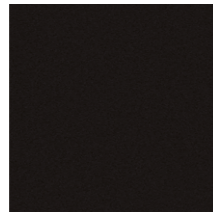

CJ
Ivory black ceramic
Ceramica Ivory Black

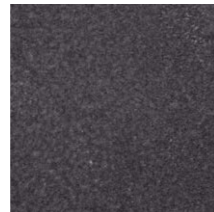

CD
Dark ceramic
Ceramica dark

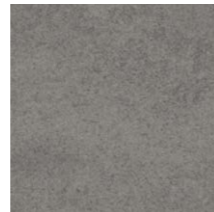

CG
Grey ceramic
Ceramica grey



CZ
Ceppo di Grè ceramic
Ceramica Ceppo di Grè

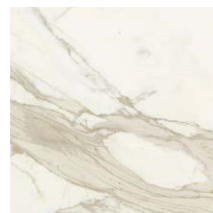

CC
Pre-polished Calacatta
ceramic
Ceramica Calacatta
Prelucidata



CX
Pre-polished Stone
Grey ceramic
Ceramica Stone Grey
Prelucidata



KC
Corten ceramic
Ceramica Corten

Ceramic Ceramica Categoria CE2



CA
Arabescato light
ceramic
Ceramica Arabescato
light

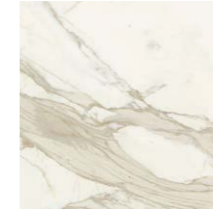

CL
Polished Calacatta
ceramic
Ceramica Calacatta
lucida



CY
Stone grey ceramic
Ceramica Stone grey



CU
Gaudi Stone ceramic
Ceramica Gaudi Stone

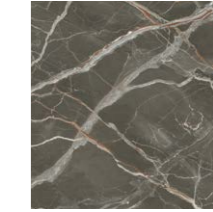

CV
Ombra di Caravaggio
ceramic
Ceramica Ombra di
Caravaggio

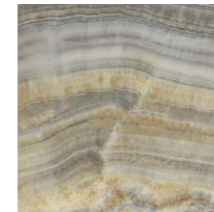

CH
Grey onyx ceramic
Ceramica Onice grigio



CI
Gold Onyx ceramic
Ceramica Onice oro

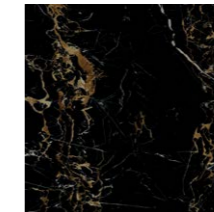

CO
Portoro ceramic
Ceramica Portoro



CQ
Polished Marquinia
ceramic
Ceramica Marquinia
lucida



CF
Eramosa ceramic
Ceramica Eramosa

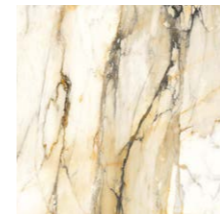

CW
Antique ceramic
Ceramica Antique

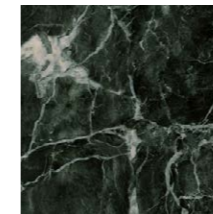

KV
Green Aver ceramic
Ceramica verde Aver

sideboard / madia

Wood

Legni



NC

Canaletto walnut
Noce Canaletto



WG

Wengé-stained oak
Rovere tinto wengè

legs / gambe

Aluminium

Alluminio



GN

Embossed black
Nero goffrato



GB

Embossed white
Caffè goffrato



GC

Embossed Mocha
Caffè goffrato



GT

Embossed clay
Caffè goffrato



LC

Polish, chr. aluminium
Alluminio cromato



BR

Burnished aluminium
Alluminio brunito

structure / struttura



GN

Embossed black
Nero goffrato



GB

Embossed white
Caffè goffrato



GC

Embossed Mocha
Caffè goffrato



GT

Embossed clay
Caffè goffrato



OA

Anodized aluminium
Alluminio anodizzato



BR

Burnished aluminium
Alluminio brunito

Vetro

Le laccature utilizzate non presentano problemi di durata: basta evitare graffi e urti contro oggetti particolarmente duri e spigolosi. Il vetro è colorato solo sulla faccia posteriore sia nei vetri laccati coprenti mono e bicolore che nei vetri acidati laccati. La tonalità dei campioni proposti è indicativa e non va pertanto intesa in senso restrittivo; può infatti differire leggermente in conformità ai margini di tolleranza riconosciuti per i materiali impiegati. I materiali impiegati possono essere puliti tranquillamente solo con acqua oppure con un detergente neutro. Evitare l'uso di abrasivi, acidi o reagenti chimici. Il vetro è interpretato attraverso la sua trasparenza, pertanto la conformità al campione può differire a seconda della superficie e degli spessori impiegati. Un esempio lampante è dato dal vetro extrachiaro che nei campioncini si presenta completamente neutro ma che nei piani di dimensioni maggiori e con spessori più consistenti assume sfumature azzurro/verdi. Per tale ragione vi preghiamo anche di segnalare con particolare attenzione articoli che debbano essere affiancati o facenti parte di una stessa commissione.

La finitura bicolore consiste nella doppia laccatura nella parte interna della lastra di vetro. La prima laccatura, visibile attraverso la trasparenza del vetro, è disponibile nelle categorie B-D. La seconda laccatura, visibile internamente, equivale al colore pastello opaco utilizzato per ottenere le finiture di cat. B. Vi facciamo presente che in questo caso l'effetto finale differisce da quello creato dalla medesima laccatura attraverso il vetro, in particolare nei colori tenui.

Specchi

Gli specchi oro e rosa potrebbero presentare delle piccole imperfezioni dovute alle caratteristiche tecniche del materiale. Non possono essere utilizzati in luoghi umidi. Pulire solo con panni asciutti.

Ceramica

I campioni riportati sono una parte delle lastre che vengono lavorate. La lastra completa si può vedere nella corrispondente cartella. Pulire utilizzando acqua e una piccola quantità di detergente neutro. Evitare l'utilizzo di detersivi contenenti cere e prodotti ceranti per evitare la formazione di strati untuosi.

Legno

I colori dei legni sono campioni indicativi. Pulire utilizzando un panno morbido inumidito.

Metalli

I colori dei metalli sono campioni indicativi. Pulire utilizzando un panno morbido inumidito.

Tessuti/Pelli/Ecopelli/Velluti

I colori dei tessuti sono campioni indicativi. Per la cura e la manutenzione fare riferimento alle indicazioni riportate nelle rispettive cartelle e alle schede tecniche fornite dai produttori.

Se permangono dubbi contattare l'azienda.

Glass

The lacquering used for our furniture is extremely durable as long as you avoid scratching it or bumping particularly hard/sharp objects against it. The glass is lacquered only on the back side both for mono or two-tones lacquered and frosted lacquered glasses. The shade of the samples is only indicative and has not to be taken as restrictive. It can in fact slightly differ in conformity to the tolerances recognized for the materials used. All the materials we use can be easily cleaned with water only or with a mild detergent. Do not use abrasive materials, acids or harsh chemicals. The glass is interpreted through its transparency, therefore the conformity to the sample might differ according to the surface and the thickness used. For example, the extralight glass is completely neutral when seen in the small samples, but it takes a light blue/greenish shade when used on bigger or thicker tops. For this reason, we beg you to indicate carefully those articles which have to be placed side by side or which are part of the same commission.

The two-tones finish consists of a double lacquering on the internal part of the glass sheet. The first lacquering, which is visible through the transparency of the glass, is available in the finishes of cat. B-D. The second lacquering, which is visible internally, is the same of the mat pastel used to get the finishes of cat. B. Please notice that the final effect is different from the one created by the same lacquering through the glass, in particular when it comes to soft colours.

Mirrors

Gold and rose mirrors could have small imperfections due to the particular technical characteristics of the material. We recommend not to use them in damp areas. Clean only with a dry cloth.

Ceramic

The shown samples are part of the bigger slabs Sovet works with. The complete slab is visible in the corresponding folder. Clean using water and a small amount of neutral detergent. Avoid using detergents with wax and waxing products to avoid the formation of greasy layers.

Wood

Wood colours are indicative samples. Clean using a damp soft cloth.

Metals

Metals colours are indicative samples. Clean using a damp soft cloth.

Fabrics/Leathers/Fake leathers/velvets

Fabrics colours are indicative samples. For care and maintenance please refer to the instructions present in the corresponding folders and to the technical sheets provided by the manufacturers.

In case of further doubt please get in touch with the factory.



Slim sideboard structure GN sideboard WG and CW top.



Slim sideboard structure GN sideboard WG top CH.



Slim sideboard structure GN sideboard WG top CH.



Slim sideboard structures GN sideboard WG and top CH.

Slim sideboard structures GN sideboard WG and top CO.

In the next page

Slim sideboard structures GN sideboard WG and top CO.

Slim sofa structures GN seat Z08.

Slim coffee table structures GN top CD.



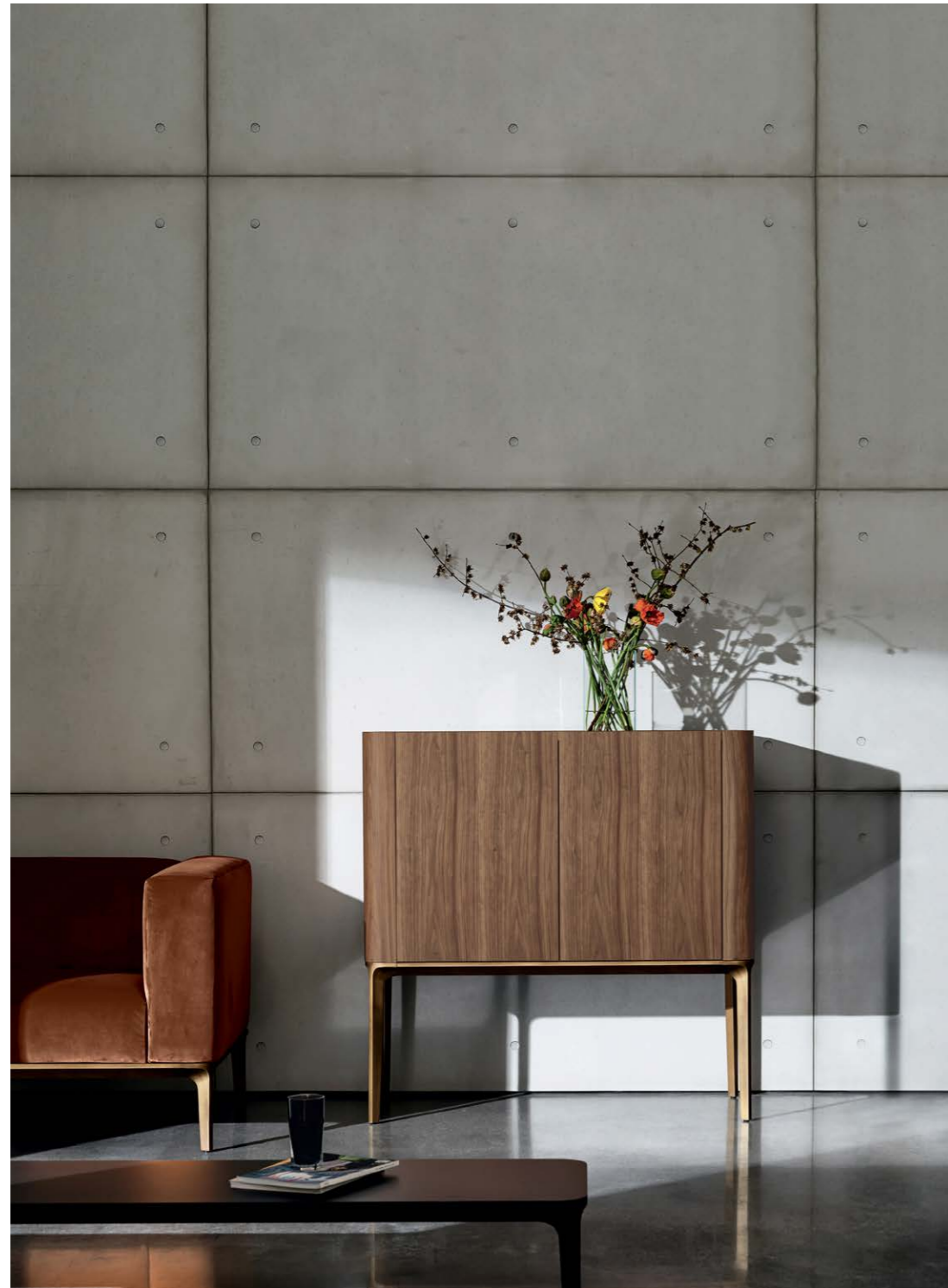

Slim sideboard structure BR sideboard NC top CO.
Slim sofa structure BR seat Z09.
Slim coffee table structures GN top CD.

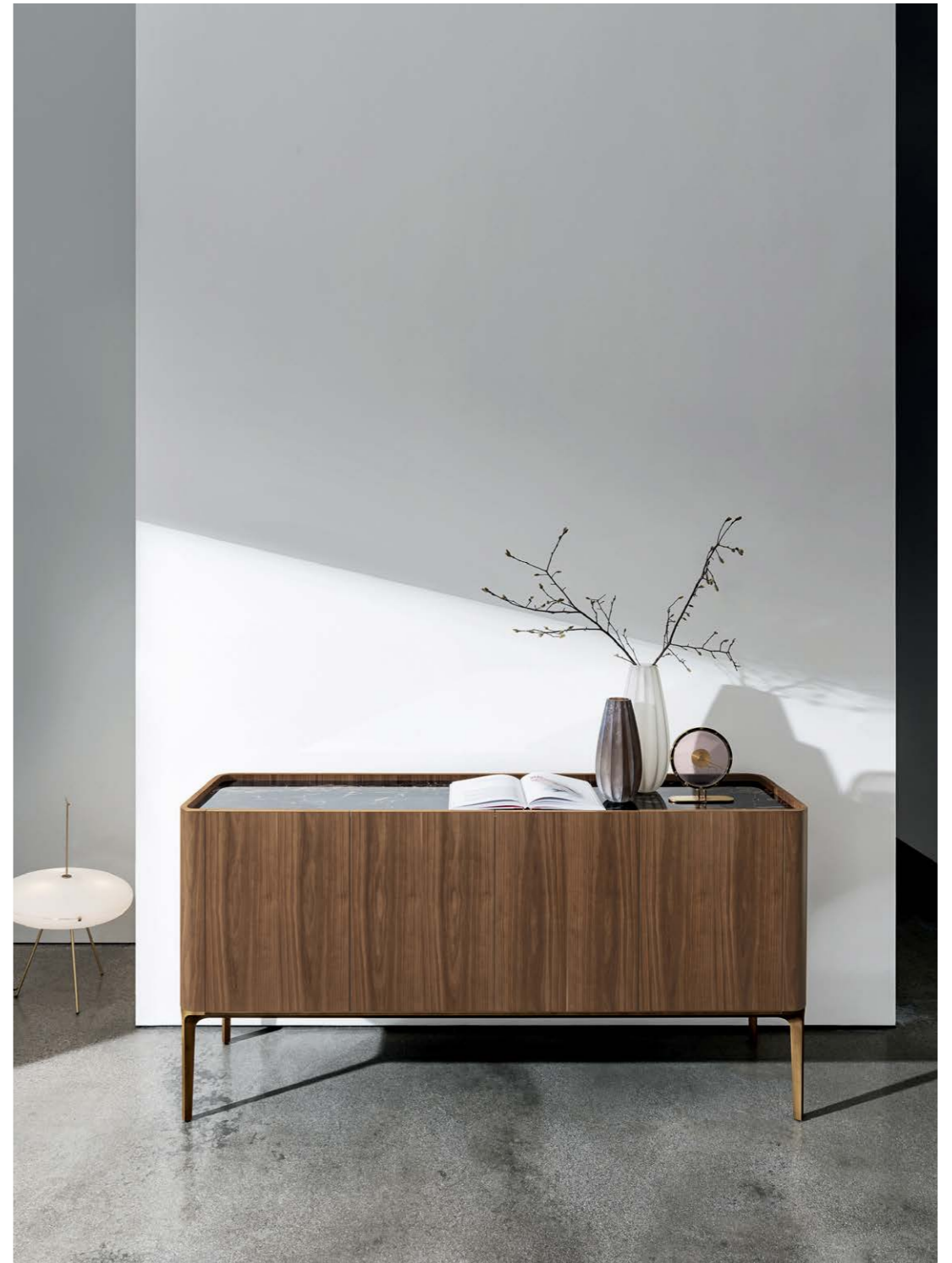

Slim sideboard structure BR sideboard NC top CO.



Slim sideboard structure GC sideboard NC top CO.



Slim sideboard structure GC sideboard NC top CO.
Slim table structure GC top CO.



sustainability is made up of facts.

Sovet has always maintained a high attention to eco-compatibility since its birth in 1987, through the selection of raw materials and the study of production processes that have the lowest impact on the environment with the aim of creating long-lasting products.

Sovet ha sempre mantenuto alta l'attenzione all'ecocompatibilità sin dalla sua nascita nel 1987, attraverso la selezione delle materie prime e lo studio di processi produttivi che abbiano il minimo impatto sull'ambiente con lo scopo di creare prodotti durevoli nel tempo.

photovoltaic systems



For its production processes, Sovet uses energy coming directly from renewable sources. Thanks to its photovoltaic systems, it is able to meet its own energy demand.

Per la sua produzione Sovet utilizza infatti energia derivante direttamente da fonti rinnovabili. Attraverso impianti fotovoltaici riesce a soddisfare il proprio fabbisogno energetico.



502695,549 kg emmissions saved per year



2989 trees saved per year



165 barrels of oil saved per year

packaging



Sovet uses cardboard packaging with limited presence of oil-derivates.

Sovet usa imballi di cartone costruiti ad hoc con limitata presenza di derivati del petroli.



reducing plastic is an habits



To reduce the consumption of plastic and disposable bottles within its offices and production, Sovet created metal water bottles.

Per ridurre il consumo di plastica e bottiglie monouso all'interno dei suoi uffici e della produzione, Sovet ha creato delle borracce in metallo.

made in italy

The creative use of industrial processes, the use of raw materials of highest quality and the scrupulous work of master craftsmen, allow Sovet to create high quality and 100% Made in Italy collections. Thanks to state-of-the-art industrial automation systems, Sovet is also able to meet also large supply needs for contract spaces, always granting the highest quality standards. The company takes a continuous search path for materials, to create an offer of accessories that complement one another, furnishing different kinds of environments with the maximum freedom when it comes to customization.

L'impiego creativo dei processi industriali, l'utilizzo di materie prime di assoluta qualità e le scrupolose lavorazioni eseguite da maestranze artigiane, permettono a Sovet di ottenere collezioni di alta qualità e 100% Made in Italy. Grazie a sistemi di automazione industriale all'avanguardia Sovet è in grado di soddisfare anche esigenze per grandi forniture destinate a spazi contract, sempre garantendo i più elevati standard qualitativi. Sovet intraprende un percorso di ricerca dei materiali per creare un'offerta di complementi che si integrino tra di loro, arredando varie tipologie di ambienti con la massima possibilità di personalizzazione.

