

SOVET

ITALIA



Denver

collection booklet

collection booklet

Denver

Design **Guido Porcellato**

“
The Denver mirrors collection embraces the new ceramic frames. The different mirror shades available for the central mirror, from the extralight to the bronzed and the smoked, allow to create unique combinations that furnish the interiors in harmony with different styles and environments.

La collezione di specchiere Denver si arricchisce con le nuove cornici in ceramica. Le diverse tonalità di specchio centrale proposte, dall'extralight al bronzo fino al fumé permettono di creare combinazioni uniche che arredano gli interni in armonia con diversi stili e ambienti.

”

Models & Dimensions

Floor or horizontal/vertical hanging mirror with aluminium structure. Central mirror available in extralight, smoked or bronzed finish. Frame available in lacquered glass, mirror or ceramic, various finishes. Available also with led lighting on the back.

Specchiera con telaio in alluminio per attacco verticale/orizzontale o con appoggio a terra. Specchio centrale disponibile nelle finiture extrachiaro, fumé o bronzo. Cornice perimetrale disponibile in vetro laccato, specchio o ceramica, varie finiture. Optional: retroilluminazione a led.

square

90x90
120x120
200x200 ▲

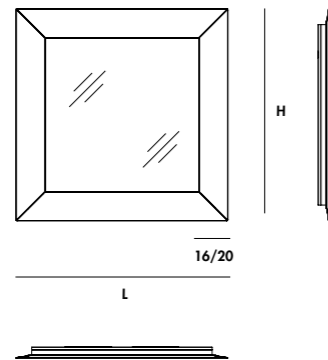

Led light 3000 K

▲ Piedini inclusi - feet included

rectangular

120x90
160x65
160x90
180x90
220x90 ▲

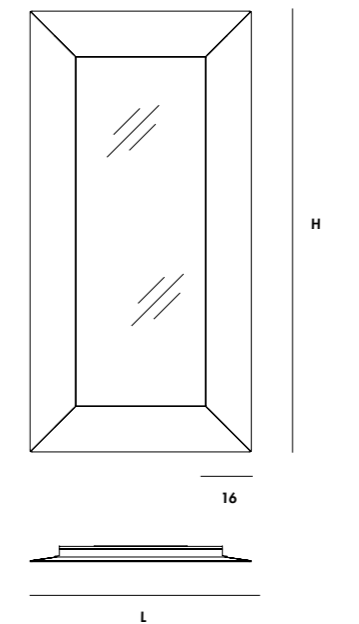

Led light 3000 K

▲ Piedini inclusi - feet included

collection
finishes



mirror / specchio

Mirror Specchio

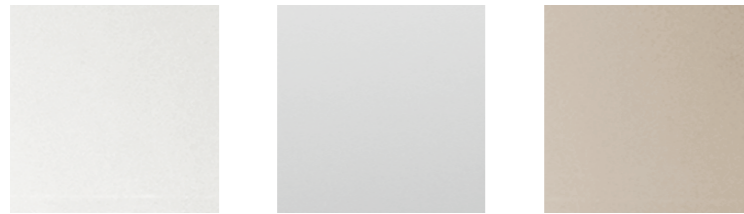

SESP
Extralight mirror
Specchio extrachiaro

SFSP
Smoked mirror
Specchio fumé

SBSP
Bronzed mirror
Specchio bronzo

frame / cornice

Mirror Specchio



SESP
Extralight mirror
Specchio extrachiaro

SFSP
Smoked mirror
Specchio fumé

SBSP
Bronzed mirror
Specchio bronzo

SRSP *
Rose mirror
Specchio rosa

SOSP *
Gold mirror
Specchio oro

Frosted mirror Specchio acidato



SEAC
Extralight frosted mirror
Specchio extrachiaro acidato

SFAC
Smoked frosted mirror
Specchio fumé acidato

SBAC
Bronzed frosted mirror
Specchio bronzo acidato

SRAC *
Rose frosted mirror
Specchio rosa acidato

SOAC *
Gold frosted mirror
Specchio oro acidato

*
Gli specchi oro e rosa potrebbero presentare delle piccole imperfezioni dovute alle caratteristiche tecniche del materiale. Non possono essere utilizzati in luoghi umidi. Pulire solo con panni asciutti.
Gold and rose mirrors could have small imperfections due to the particular technical characteristics of the material. We recommend not to use them in damp areas. Clean only with a dry cloth.

Glass Vetro

CAT. B



TEB1
Extralight glass lacquered milky white
Vetro extrachiaro laccato bianco latte

TEC1
Extralight glass lacquered mocha
Vetro extrachiaro laccato caffè

TEC2
Extralight glass lacquered clay
Vetro extrachiaro laccato creta

TEC3
Extralight glass lacquered cement
Vetro extrachiaro laccato col. cemento

TER4
Extralight glass lacquered rust
Vetro extrachiaro laccato col. ruggine

CAT. D

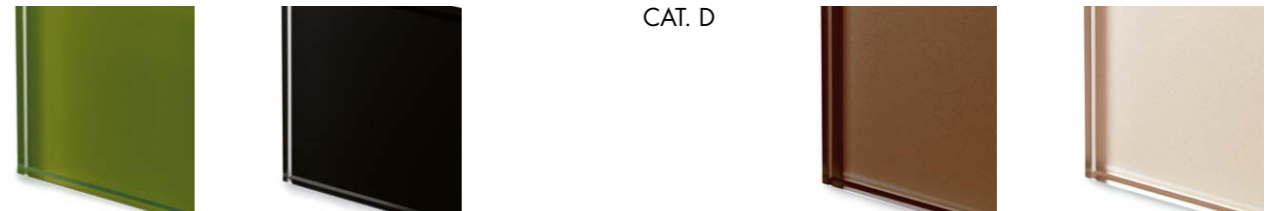

TEV2
Extralight glass lacquered moss green
Vetro extrachiaro laccato col. muschio

TEN1
Extralight glass lacquered black
Vetro extrachiaro laccato nero

TEM6
Vetro extrachiaro laccato col. tabacco
Extralight glass lacquered tobacco

TES1
Vetro extrachiaro laccato champagne
Extralight glass lacquered champagne

Frosted glass Vetro acidato

CAT. E



AEB1
Extralight glass lacquered mocha
Vetro extrachiaro laccato caffè

AEC2
Frosted clay glass
Vetro acidato creta

AEC3
Frosted cement glass
Vetro acidato col. cemento

AES1
Frosted champagne glass
Vetro acidato champagne

Ceramic
Ceramica
Categoria CE1

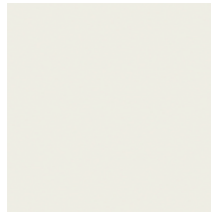

CT
Ceramic titanio
Ceramica titanio



CJ
Ivory black ceramic
Ceramica Ivory Black

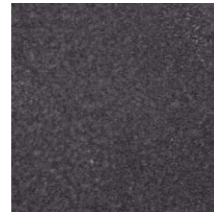

CD
Dark ceramic
Ceramica dark

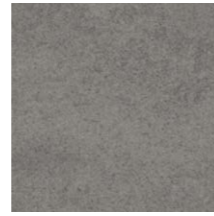

CG
Grey ceramic
Ceramica grey

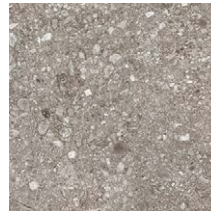

CZ
Ceppo di Grè ceramic
Ceramica Ceppo di Grè

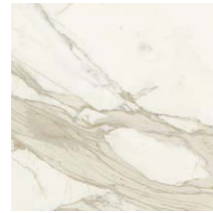

CC
Pre-polished Calacatta ceramic
Ceramica Calacatta
Preucidata



CX
Pre-polished Stone Grey ceramic
Ceramica Stone Grey
Preucidata



KC
Corten ceramic
Ceramica Corten

Ceramic
Ceramica
Categoria CE2



CA
Arabescato light ceramic
Ceramica Arabescato
light

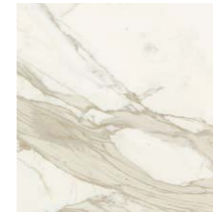

CL
Polished Calacatta ceramic
Ceramica Calacatta
lucida

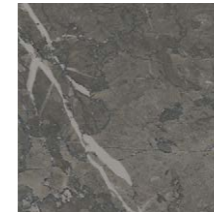

CY
Stone grey ceramic
Ceramica Stone grey



CU
Gaudi Stone ceramic
Ceramica Gaudi Stone

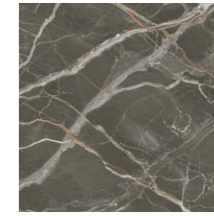

CV
Ombra di Caravaggio ceramic
Ceramica Ombra di
Caravaggio

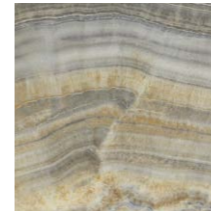

CH
Grey onyx ceramic
Ceramica Onice grigio



CI
Gold Onyx ceramic
Ceramica Onice oro

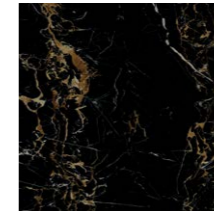

CO
Portoro ceramic
Ceramica Portoro



CQ
Polished Marquinia ceramic
Ceramica Marquinia
lucida



CF
Eramosa ceramic
Ceramica Eramosa



CW
Antique ceramic
Ceramica Antique

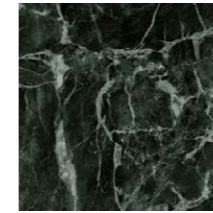

KV
Green Aver ceramic
Ceramica Verde aver

Vetro

Le laccature utilizzate non presentano problemi di durata: basta evitare graffi e urti contro oggetti particolarmente duri e spigolosi. Il vetro è colorato solo sulla faccia posteriore sia nei vetri laccati coprenti mono e bicolore che nei vetri acidati laccati. La tonalità dei campioni proposti è indicativa e non va pertanto intesa in senso restrittivo; può infatti differire leggermente in conformità ai margini di tolleranza riconosciuti per i materiali impiegati. I materiali impiegati possono essere puliti tranquillamente solo con acqua oppure con un detergente neutro. Evitare l'uso di abrasivi, acidi o reagenti chimici. Il vetro è interpretato attraverso la sua trasparenza, pertanto la conformità al campione può differire a seconda della superficie e degli spessori impiegati. Un esempio lampante è dato dal vetro extrachiaro che nei campioncini si presenta completamente neutro ma che nei piani di dimensioni maggiori e con spessori più consistenti assume sfumature azzurro/verdi. Per tale ragione vi preghiamo anche di segnalare con particolare attenzione articoli che debbano essere affiancati o facenti parte di una stessa commissione.

La finitura bicolore consiste nella doppia laccatura nella parte interna della lastra di vetro. La prima laccatura, visibile attraverso la trasparenza del vetro, è disponibile nelle categorie B-D. La seconda laccatura, visibile internamente, equivale al colore pastello opaco utilizzato per ottenere le finiture di cat. B. Vi facciamo presente che in questo caso l'effetto finale differisce da quello creato dalla medesima laccatura attraverso il vetro, in particolare nei colori tenui.

Specchi

Gli specchi oro e rosa potrebbero presentare delle piccole imperfezioni dovute alle caratteristiche tecniche del materiale. Non possono essere utilizzati in luoghi umidi. Pulire solo con panni asciutti.

Ceramica

I campioni riportati sono una parte delle lastre che vengono lavorate. La lastra completa si può vedere nella corrispondente cartella. Pulire utilizzando acqua e una piccola quantità di detergente neutro. Evitare l'utilizzo di detersivi contenenti cere e prodotti ceranti per evitare la formazione di strati untuosi.

Legno

I colori dei legni sono campioni indicativi. Pulire utilizzando un panno morbido inumidito.

Metalli

I colori dei metalli sono campioni indicativi. Pulire utilizzando un panno morbido inumidito.

Tessuti/Pelli/Ecopelli/Velluti

I colori dei tessuti sono campioni indicativi. Per la cura e la manutenzione fare riferimento alle indicazioni riportate nelle rispettive cartelle e alle schede tecniche fornite dai produttori.

Se permangono dubbi contattare l'azienda.

Glass

The lacquering used for our furniture is extremely durable as long as you avoid scratching it or bumping particularly hard/sharp objects against it. The glass is lacquered only on the back side both for mono or two-tones lacquered and frosted lacquered glasses. The shade of the samples is only indicative and has not to be taken as restrictive. It can in fact slightly differ in conformity to the tolerances recognized for the materials used. All the materials we use can be easily cleaned with water only or with a mild detergent. Do not use abrasive materials, acids or harsh chemicals. The glass is interpreted through its transparency, therefore the conformity to the sample might differ according to the surface and the thickness used. For example, the extralight glass is completely neutral when seen in the small samples, but it takes a light blue/greenish shade when used on bigger or thicker tops. For this reason, we beg you to indicate carefully those articles which have to be placed side by side or which are part of the same commission.

The two-tones finish consists of a double lacquering on the internal part of the glass sheet. The first lacquering, which is visible through the transparency of the glass, is available in the finishes of cat. B-D. The second lacquering, which is visible internally, is the same of the mat pastel used to get the finishes of cat. B. Please notice that the final effect is different from the one created by the same lacquering through the glass, in particular when it comes to soft colours.

Mirrors

Gold and rose mirrors could have small imperfections due to the particular technical characteristics of the material. We recommend not to use them in damp areas. Clean only with a dry cloth.

Ceramic

The shown samples are part of the bigger slabs Sovet works with. The complete slab is visible in the corresponding folder. Clean using water and a small amount of neutral detergent. Avoid using detergents with wax and waxing products to avoid the formation of greasy layers.

Wood

Wood colours are indicative samples. Clean using a damp soft cloth.

Metals

Metals colours are indicative samples. Clean using a damp soft cloth.

Fabrics/Leathers/Fake leathers/velvets

Fabrics colours are indicative samples. For care and maintenance please refer to the instructions present in the corresponding folders and to the technical sheets provided by the manufacturers.

In case of further doubt please get in touch with the factory.



Denver mirror frame CU mirror SBSP.
Denver mirror frame CA mirror SESP.
Bugatti structure GC seat 190 Hallingdal.

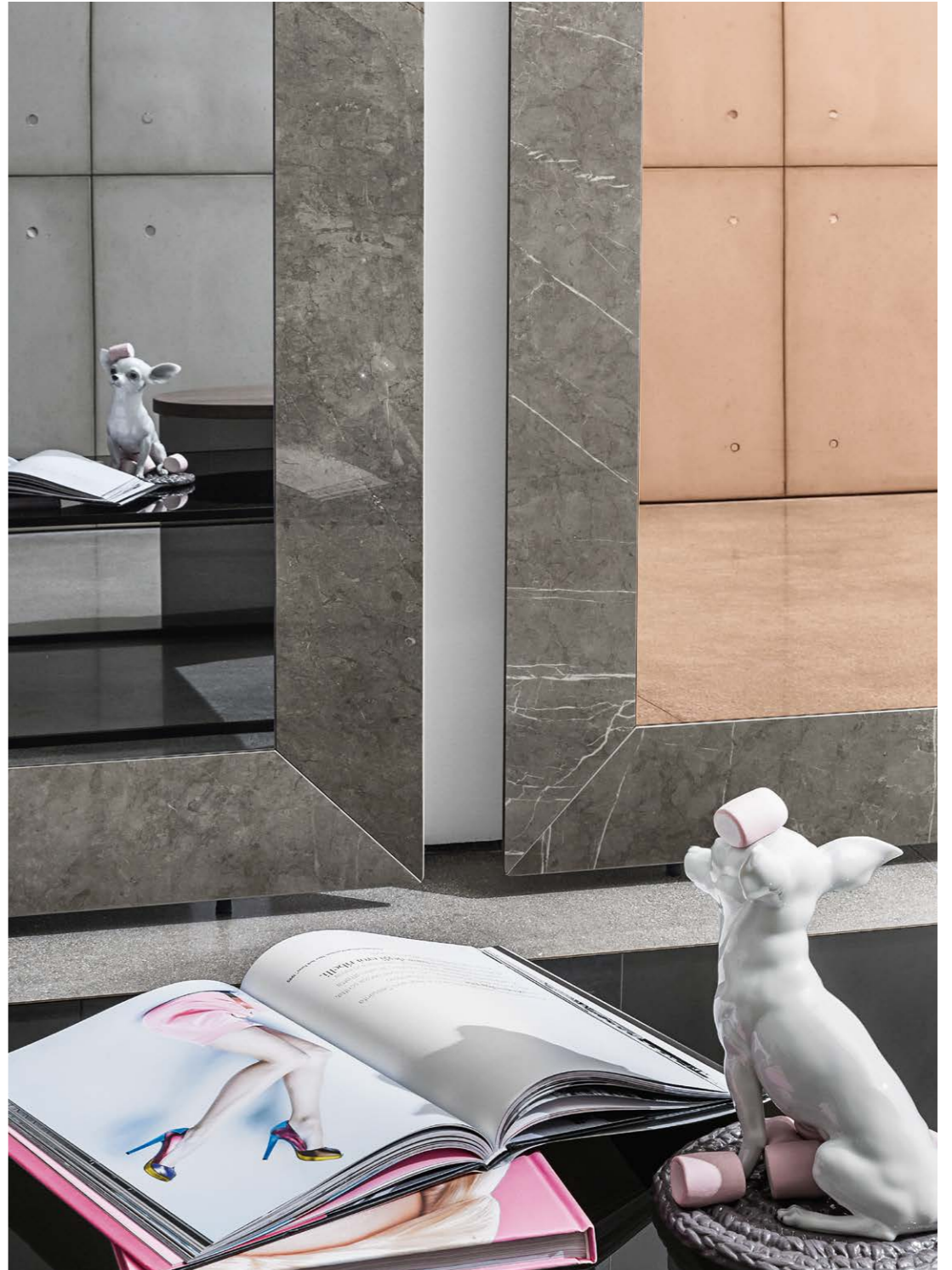

Denver frame CY mirror SFSP / SRSP.



Denver frame CI mirror SBSP.
Magda structure CI mirror SBSP.



Denver frame SFAC mirror SESP.
Slim console structure GN mirror TEN1.

sustainability is made up of facts.

Sovet has always maintained a high attention to eco-compatibility since its birth in 1987, through the selection of raw materials and the study of production processes that have the lowest impact on the environment with the aim of creating long-lasting products.

Sovet ha sempre mantentenuo alta l'attenzione all'ecocompatibilità sin dalla sua nascita nel 1987, attraverso la selezione delle materie prime e lo studio di processi produttivi che abbiano il minimo impatto sull'ambiente con lo scopo di creare prodotti durevoli nel tempo.

photovoltaic systems



For its production processes, Sovet uses energy coming directly from renewable sources. Thanks to its photovoltaic systems, it is able to meet its own energy demand.

Per la sua produzione Sovet utilizza infatti energia derivante direttamente da fonti rinnovabili. Attraverso impianti fotovoltaici riesce a soddisfare il proprio fabbisogno energetico.



502695,549 kg emmissions saved per year



2989 trees saved per year



165 barrels of oil saved per year

packaging



Sovet uses cardboard packaging with limited presence of oil-derivates.

Sovet usa imballi di cartone costruiti ad hoc con limitata presenza di derivati del petroli.



reducing plastic is an habits



To reduce the consumption of plastic and disposable bottles within its offices and production, Sovet created metal water bottles.

Per ridurre il consumo di plastica e bottiglie monouso all'interno dei suoi uffici e della produzione, Sovet ha creato delle borracce in metallo.

made in italy

The creative use of industrial processes, the use of raw materials of highest quality and the scrupulous work of master craftsmen, allow Sovet to create high quality and 100% Made in Italy collections. Thanks to state-of-the-art industrial automation systems, Sovet is also able to meet also large supply needs for contract spaces, always granting the highest quality standards. The company takes a continuous search path for materials, to create an offer of accessories that complement one another, furnishing different kinds of environments with the maximum freedom when it comes to customization.

L'impiego creativo dei processi industriali, l'utilizzo di materie prime di assoluta qualità e le scrupolose lavorazioni eseguite da maestranze artigiane, permettono a Sovet di ottenere collezioni di alta qualità e 100% Made in Italy. Grazie a sistemi di automazione industriale all'avanguardia Sovet è in grado di soddisfare anche esigenze per grandi forniture destinate a spazi contract, sempre garantendo i più elevati standard qualitativi. Sovet intraprende un percorso di ricerca dei materiali per creare un'offerta di complementi che si integrino tra di loro, arredando varie tipologie di ambienti con la massima possibilità di personalizzazione.

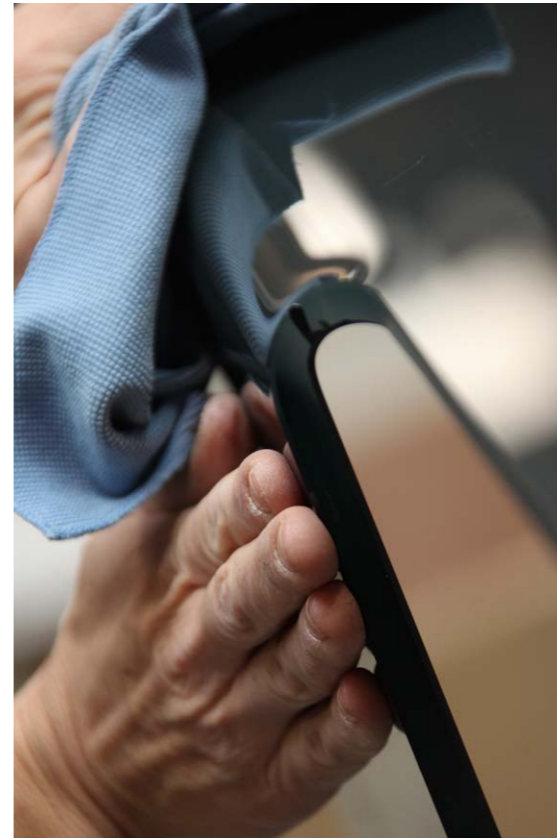



sovet.com