

# SOVET

ITALIA



# Arkos

collection booklet

# collection booklet

## Arkos

Design **Gianluigi Landoni**

“  
**From a careful aluminium die-casting  
arises the perfect synthesis between  
form and technology: Arkos.  
A collection of tables interpreting  
the different living styles in  
contemporary interiors.**

Da un'accurata pressofusione di  
alluminio nasce la sintesi perfetta  
tra forme e tecnologia: Arkos.  
Una collezione di tavoli capace di  
interpretare i diversi stili dell'abitare  
gli interni contemporanei.

”

## Models & Dimensions

Dining table with aluminium base, various finishes. Top available in different measures, materials and finishes.

Tavolo con base in alluminio, varie finiture. Top disponibile in varie misure, materiali e finiture.

### round

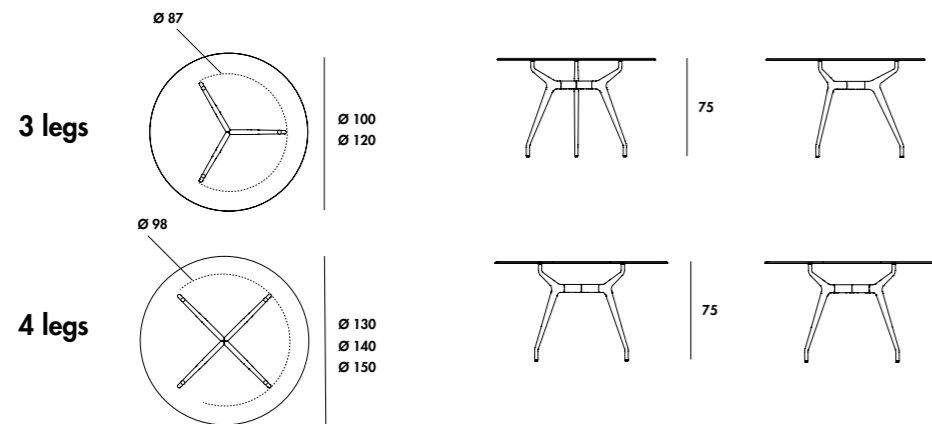

Ø100x75h  
 Ø120x75h  
 Ø130x75h  
 Ø140x75h  
 Ø150x75h

### rectangular

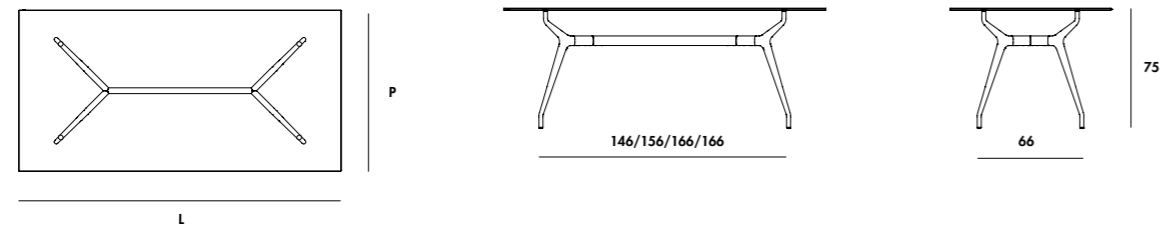

180x90x75h  
 200x90x75h  
 240x120x75h  
 250x100x75h  
 300x120x75h

### shaped square

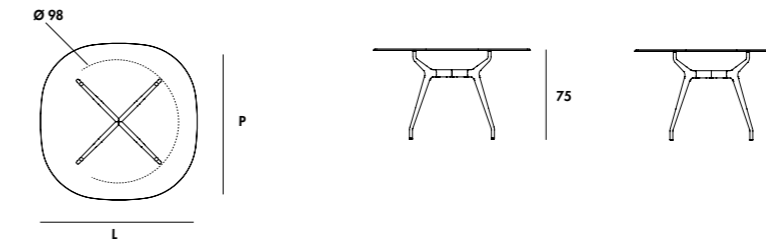

100x100x75h  
 120x120x75h  
 130x130x75h  
 140x140x75h  
 150x150x75h

### shaped 02

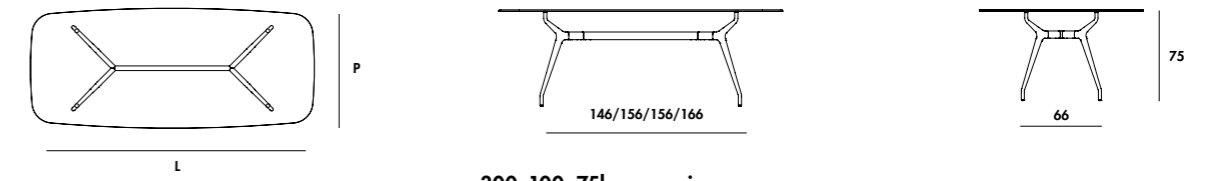

180x93x75h  
 200x93x75h  
 220x93x75h  
 260x100x75h  
 300x100x75h

300x100x75h cm version

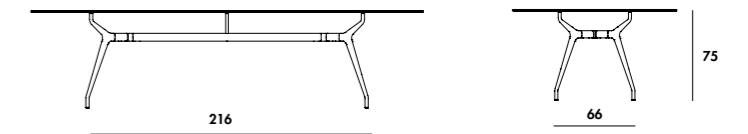

### shaped 01

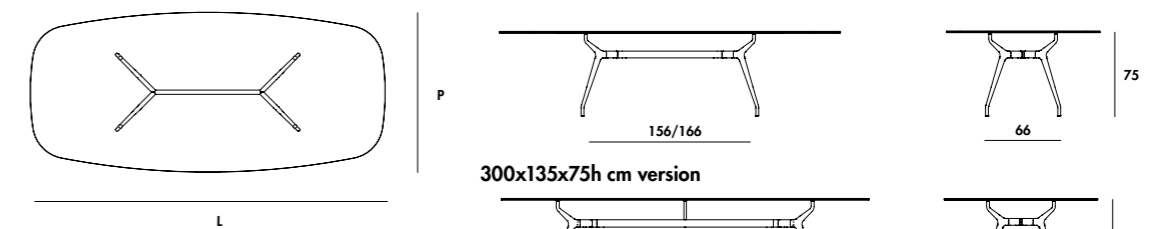

220x115x75h  
 250x120x75h  
 300x135x75h

300x135x75h cm version

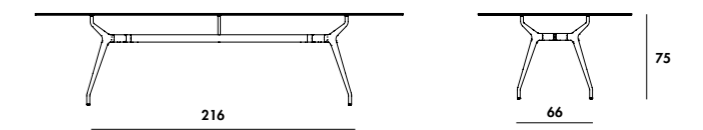



/ The Arkos series arises from the desire to relive the taste of the Italian domestic interiors of the 50s. The aerodynamic lines and curvilinear tensions of the shape are inspired by the designs of Ico Parisi and respect the emblem of the Italian furniture style of these years. Reinterpreted with a contemporary taste and made with cutting-edge techniques such as the aluminium die-casting for the base, Arkos stands out for the strong structural bareness of the X or Y legs with its thin and slender shape.

/ La serie Arkos nasce dalla volontà di rivivere il sapore degli interni domestici italiani degli anni 50. Le linee aerodinamiche e tensioni curvilinee della forma si ispirano ai progetti di Ico Parisi e rispettano l'emblema dello stile del mobile italiano di questi anni. Reinterpretato con un gusto contemporaneo e realizzato con tecniche d'avanguardia come la pressofusione di alluminio per la base, Arkos si distingue per la spiccata nudità strutturale delle gambe a X o Y con la sua esile e longilinea forma.





collection  
finishes



# top

## Glass Vetro



**TETE**  
Extralight glass  
Vetro extrachiaro



**TTF**  
Smoked glass  
Vetro fumé

### CAT. B



**TEB1**  
Extralight glass lacquered  
milky white  
Vetro extrachiaro laccato  
bianco latte



**TEC1**  
Extralight glass  
lacquered mocha  
Vetro extrachiaro  
laccato caffè



**TEC2**  
Extralight glass  
lacquered clay  
Vetro extrachiaro  
laccato creta



**TEC3**  
Extralight glass  
lacquered cement  
Vetro extrachiaro  
laccato col. cemento



**TER4**  
Extralight glass  
lacquered rust  
Vetro extrachiaro  
laccato col. ruggine



**TEV2**  
Extralight glass  
lacquered moss green  
Vetro extrachiaro  
laccato col. muschio



**TEN1**  
Extralight glass  
lacquered black  
Vetro extrachiaro  
laccato nero

### CAT. D



**TEM6**  
Vetro extrachiaro  
laccato col. tabacco  
Extralight glass  
lacquered tobacco



**TES1**  
Vetro extrachiaro  
laccato champagne  
Extralight glass lacquered  
champagne

## Frosted glass Vetro acidato

### CAT. E



**AEA**  
Vetro acidato  
Frosted glass



**AEB1**  
Extralight glass  
lacquered mocha  
Vetro extrachiaro  
laccato caffè



**AEC2**  
Frosted clay glass  
Vetro acidato creta



**AEC3**  
Frosted  
cement glass  
Vetro acidato  
col. cemento



**AES1**  
Frosted champagne  
glass  
Vetro acidato  
champagne

## Net glass

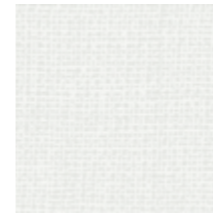

**NEB1**  
White Net glass  
Net glass bianco

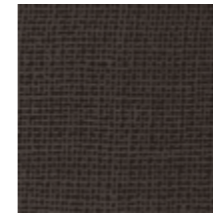

**NEC1**  
Mocha Net glass  
Net glass caffè

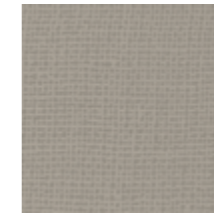

**NEC2**  
Clay Net glass  
Net glass creta



**NEC3**  
Cement Net glass  
Net glass col. cemento

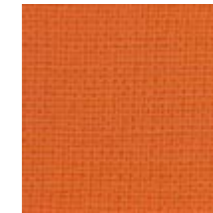

**NER4**  
Rust Net glass  
Net glass col. ruggine

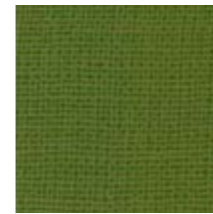

**NEV2**  
Moss green Net glass  
Net glass col. muschio

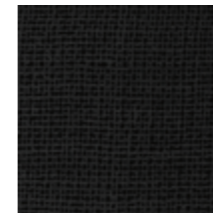

**NEN1**  
Black Net glass  
Net glass nero

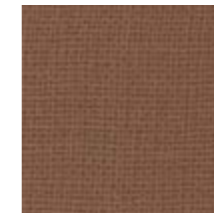

**NEM6**  
Tobacco  
Net glass  
Net glass col.  
tabacco



**NES1**  
Champagne  
Net glass  
Net glass  
champagne

## Liquid glass

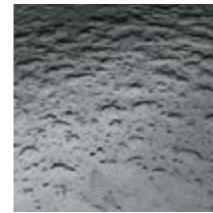

**LFLF**  
Smoked Liquid glass

## Materia



**MESP**  
Extralight mirror  
materia  
Materia extrachiaro  
specchio



**MBSP**  
Extralight bronzed  
materia  
Materia extrachiaro  
bronzo



**MES1**  
Extralight champagne  
materia  
Materia extrachiaro  
champagne



**Wood**  
Legni

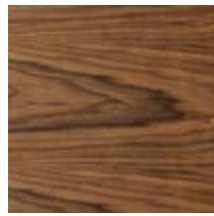

**NC**  
Canaletto walnut  
Noce Canaletto



**RN**  
Natural oak wood  
Rovere naturale



**RG**  
Grey lacquered oak  
Rovere tinto grigio



**WG**  
Wengé-stained oak  
Rovere tinto wengé

**Ceramic**  
Ceramica  
**Categoria CE1**

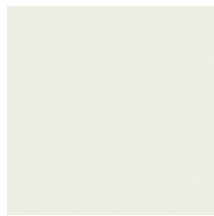

**CT**  
Ceramic titanio  
Ceramica titanio



**CJ**  
Ivory black ceramic  
Ceramica Ivory Black



**CD**  
Dark ceramic  
Ceramica dark

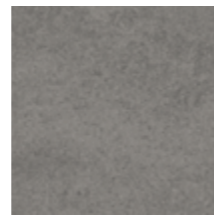

**CG**  
Grey ceramic  
Ceramica grey



**CZ**  
Ceppo di Grè ceramic  
Ceramica Ceppo di Grè

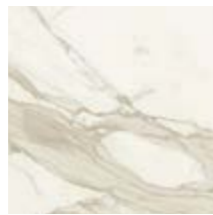

**CC**  
Pre-polished Calacatta ceramic  
Ceramica Calacatta Prelucidata



**CX**  
Pre-polished Stone Grey ceramic  
Ceramica Stone Grey Prelucidata

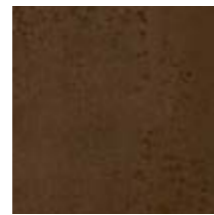

**KC**  
Corten ceramic  
Ceramica Corten

**Ceramic**  
Ceramica  
**Categoria CE2**



**CA**  
Arabescato light ceramic  
Ceramica Arabescato light

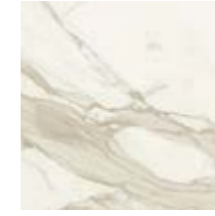

**CL**  
Polished Calacatta ceramic  
Ceramica Calacatta lucida



**CY**  
Stone grey ceramic  
Ceramica Stone grey



**CU**  
Gaudi Stone ceramic  
Ceramica Gaudi Stone

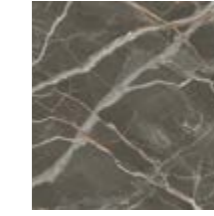

**CV**  
Ombra di Caravaggio ceramic  
Ceramica Ombra di Caravaggio

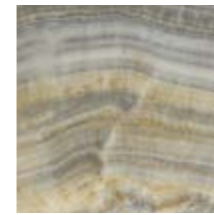

**CH**  
Grey onyx ceramic  
Ceramica Onice grigio



**CI**  
Gold Onyx ceramic  
Ceramica Onice oro

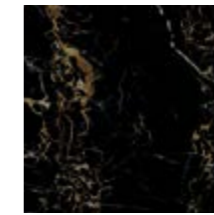

**CO**  
Portoro ceramic  
Ceramica Portoro



**CQ**  
Polished Marquinia ceramic  
Ceramica Marquinia lucida



**CF**  
Eramosa ceramic  
Ceramica Eramosa



**CW**  
Antique ceramic  
Ceramica Antique

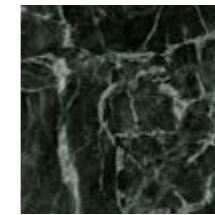

**KV**  
Green Aver ceramic  
Ceramica Verde aver

**Aluminium**

Alluminio

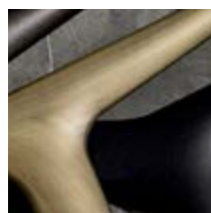
**GN****Embossed black**  
Nero goffrato**GB****Embossed white**  
Bianco goffrato**GC****Embossed Mocha**  
Caffè goffrato**GT****Embossed clay**  
Creta goffrato**BR****Burnished metal**  
Metallo brunito**Materiali e manutenzione**

ITA

**Vetro**

Le laccature utilizzate non presentano problemi di durata: basta evitare graffi e urti contro oggetti particolarmente duri e spigolosi. Il vetro è colorato solo sulla faccia posteriore sia nei vetri laccati coprenti mono e bicolore che nei vetri acidati laccati. La tonalità dei campioni proposti è indicativa e non va pertanto intesa in senso restrittivo; può infatti differire leggermente in conformità ai margini di tolleranza riconosciuti per i materiali impiegati. I materiali impiegati possono essere puliti tranquillamente solo con acqua oppure con un detergente neutro. Evitare l'uso di abrasivi, acidi o reagenti chimici. Il vetro è interpretato attraverso la sua trasparenza, pertanto la conformità al campione può differire a seconda della superficie e degli spessori impiegati. Un esempio lampante è dato dal vetro extrachiaro che nei campioncini si presenta completamente neutro ma che nei piani di dimensioni maggiori e con spessori più consistenti assume sfumature azzurro/verdi. Per tale ragione vi preghiamo anche di segnalare con particolare attenzione articoli che debbano essere affiancati o facenti parte di una stessa commissione.

La finitura bicolore consiste nella doppia laccatura nella parte interna della lastra di vetro. La prima laccatura, visibile attraverso la trasparenza del vetro, è disponibile nelle categorie B-D. La seconda laccatura, visibile internamente, equivale al colore pastello opaco utilizzato per ottenere le finiture di cat. B. Vi facciamo presente che in questo caso l'effetto finale differisce da quello creato dalla medesima laccatura attraverso il vetro, in particolare nei colori tenui.

**Specchi**

Gli specchi oro e rosa potrebbero presentare delle piccole imperfezioni dovute alle caratteristiche tecniche del materiale. Non possono essere utilizzati in luoghi umidi. Pulire solo con panni asciutti.

**Ceramica**

I campioni riportati sono una parte delle lastre che vengono lavorate. La lastra completa si può vedere nella corrispondente cartella. Pulire utilizzando acqua e una piccola quantità di detergente neutro. Evitare l'utilizzo di detersivi contenenti cere e prodotti ceranti per evitare la formazione di strati untuosi.

**Legno**

I colori dei legni sono campioni indicativi. Pulire utilizzando un panno morbido inumidito.

**Metalli**

I colori dei metalli sono campioni indicativi. Pulire utilizzando un panno morbido inumidito.

**Tessuti/Pelli/Ecopelli/Velluti**

I colori dei tessuti sono campioni indicativi. Per la cura e la manutenzione fare riferimento alle indicazioni riportate nelle rispettive cartelle e alle schede tecniche fornite dai produttori.

Se permangono dubbi contattare l'azienda.

**Materials and maintenance**

ENG

**Glass**

The lacquering used for our furniture is extremely durable as long as you avoid scratching it or bumping particularly hard/sharp objects against it. The glass is lacquered only on the backboth for mono or two-tones lacquered and frosted lacquered glasses. The shade of the samples is only indicative and must not be taken as restrictive. It can in fact slightly differ in compliance with the tolerances recognized for the materials used. All our materials we use can be easily cleaned with water only or with a mild detergent. Do not use abrasive products, acids or harsh chemicals. The glass is interpreted through its transparency, therefore the conformity to the sample might differ according to the surface and the thickness used. For example, the extralight glass is completely neutral in the small samples, but it takes a light blue/green shade when used on bigger or thicker tops. For this reason, we ask you to indicate carefully those articles which have to be placed side by side or are part of the same commission.

The two-tone finish consists of a double lacquering on the internal part of the glass sheet. The first lacquering, which is visible through the transparency of the glass, is available in the finishes of cat. B-D. The second lacquering, which is visible internally, is the same as of the mat te pastels used for the finishes of cat. B. Please notice that the final effect is different from the one created by the same lacquering through the glass, in particularly when it comes to soft colours.

**Mirrors**

Gold and rose mirrors could have small imperfections due to the technical characteristics of the material. We recommend not to use them in damp areas. Clean only with a dry cloth.

**Ceramic**

The samples shown are part of the bigger slabs Sovet works with. The complete slab is visible in the corresponding folder. Clean using water and a small amount of neutral detergent. Avoid using detergents with wax and waxing products to avoid the formation of greasy layers.

**Wood**

Wood colours are indicative samples. Clean using a damp soft cloth.

**Metals**

Metal colours are indicative samples. Clean using a damp soft cloth.

**Fabrics/Leathers/Fake leathers/Velvets**

Fabric colours are indicative samples. For care and maintenance please refer to the instructions present in the corresponding folders and to the technical sheets provided by the manufacturers.

In case of further doubts please get in touch with the factory.





Arkos structure GN top TTF.  
 Sila cone shaped structure GN seat 153 Hallingdal.  
 Slim sideboard structure GN module WG.



Arkos structure GN top TTF.  
 Slim sideboard structure GN module WG.





Arkos structure GN top TTF.  
Sila cone shaped structure GN seat 153 Hallingdal.  
Slim sideboard structure GN module WG.





Arkos shaped structure GN top TFTF. Brass lacquered feet.  
Sila structure GN seat F12 Trevira.





Arkos structure BR top CL.  
 Cadira S structure BR seat Z03 velvet.  
 Magda structure CI doors SBSF.



Arkos structure GN top CW. Brass lacquered feet.  
 Cadira structure GN seat Z01 velvet.  
 Bugatti structure BR seat 103 Hallingdal 65.  
 Combi structure BR mirror SESF/SFSP.





Arkos structure BR top TETE.  
Cadeira S structure BR seat Z03 velvet.





Arkos structure BR top MESP.  
Cadeira structure BR seat Z01 velvet.











Arkos structure GN top LFLF.  
Autumn structure DF seat 103 Hallingdal.



Arkos structure GN top LFLF.







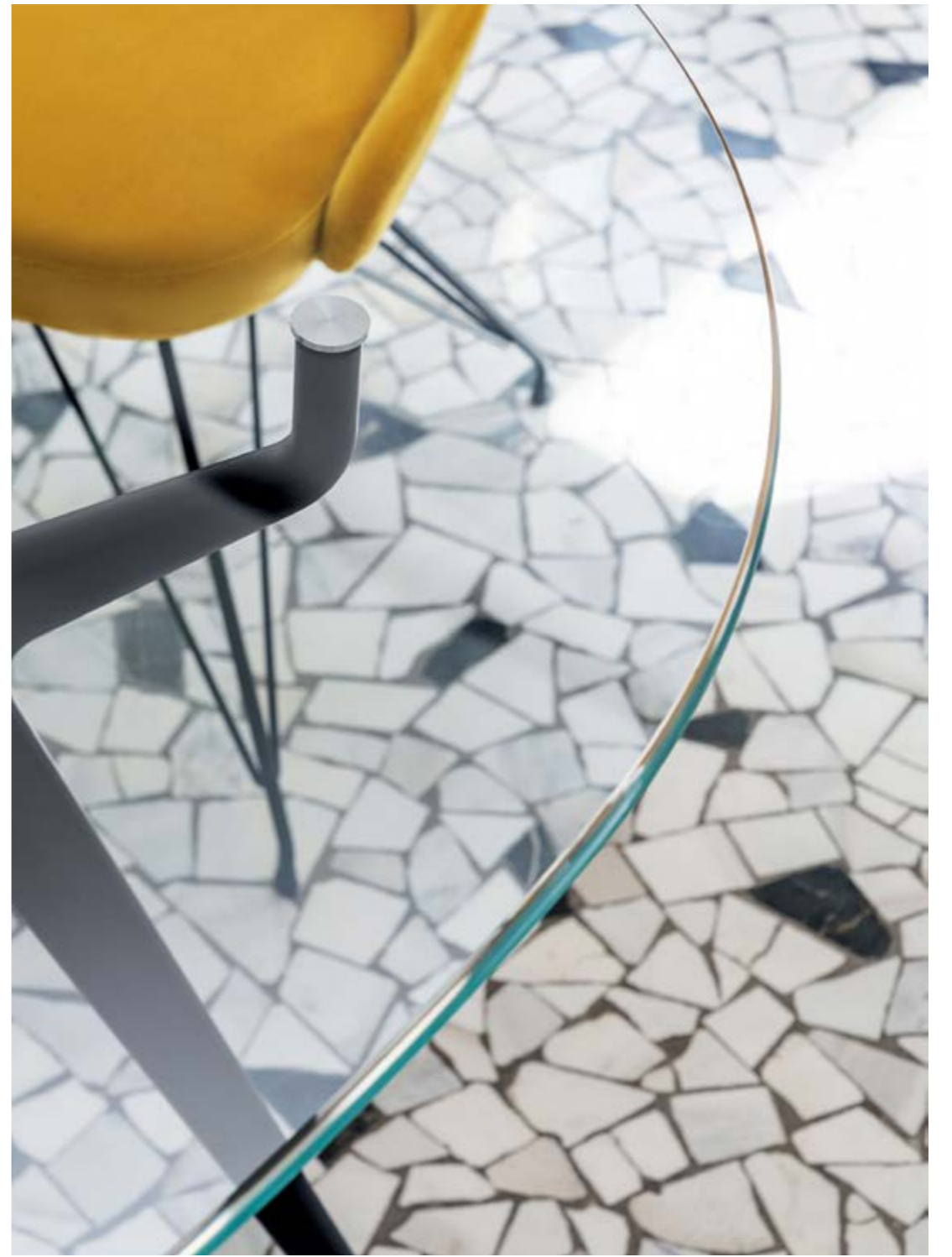

Arkos structure GN top TETE.  
Cadira S wire structure GN seat Z08 velvet.

# designer

## Gianluigi Landoni

**Gianluigi Landoni, graduated in architecture at Politecnico di Milano, in 1985 he participated to the founding of the design trend group Amalgama. From 1988 to 1990 project manager at Rodolfo Bonetto's studio. From 1991 partner of studio Progetica Design where he carries out research and development of industrial design, deepening the themes of product design. He has carried out his own professional activity as a consultant to "design oriented" companies in various productive sectors, and he founded with Rosaria Sofia Galli ALTROdesign multidisciplinary studio. At the same time he works on set-ups and realizations for furnishing companies in the hotel and commercial sector. He has also participated in exhibitions and competitions, receiving prizes and awards, not least the report to the 1991 edition of the Compasso d'Oro and subsequent Premio Compasso d'Oro in the 1998 edition. First prize Competition ADI/Expo 2015.**

Gianluigi Landoni si è laureato in architettura al Politecnico di Milano. Nel 1985 ha fondato il gruppo di tendenza di design "Amalgama". Ha lavorato per lo studio Rodolfo Bonetto dal 1988 al 1990, e dal 1997 è partner dello studio Progetica Design, dove svolge un progetto di ricerca e sviluppo del design industriale e di prodotto. Ha anche fondato lo studio multidisciplinare ALTROdesign con Rosaria Sofia Galli. Dal 2001 svolge l'attività professionale in proprio come consulente ad aziende "design oriented" in vari settori produttivi, e si occupa parallelamente di allestimenti e realizzazioni per aziende di arredamento nel settore alberghiero e commerciale. Ha inoltre partecipato a numerose mostre e concorsi, ricevendo premi e riconoscimenti, non ultima la segnalazione all'edizione 1991 del Compasso d'oro e successivo Premio Compasso d'oro nell'edizione del 1998. È membro dell'Osservatorio permanente del design, dell'ADI Design Index e del Consiglio direttivo ADI Lombardia.





# sustainability is made up of facts.

Sovet has always maintained a high attention to eco-compatibility since its birth in 1987, through the selection of raw materials and the study of production processes that have the lowest impact on the environment with the aim of creating long-lasting products.

Sovet ha sempre mantentenuo alta l'attenzione all'ecocompatibilità sin dalla sua nascita nel 1987, attraverso la selezione delle materie prime e lo studio di processi produttivi che abbiano il minimo impatto sull'ambiente con lo scopo di creare prodotti durevoli nel tempo.

## photovoltaic systems



For its production processes, Sovet uses energy coming directly from renewable sources. Thanks to its photovoltaic systems, it is able to meet its own energy demand.

Per la sua produzione Sovet utilizza infatti energia derivante direttamente da fonti rinnovabili. Attraverso impianti fotovoltaici riesce a soddisfare il proprio fabbisogno energetico.



502695,549 kg emmissions saved per year



2989 trees saved per year



165 barrels of oil saved per year

## packaging



Sovet uses cardboard packaging with limited presence of oil-derivates.

Sovet usa imballi di cartone costruiti ad hoc con limitata presenza di derivati del petroli.

## reducing plastic is an habits



To reduce the consumption of plastic and disposable bottles within its offices and production, Sovet created metal water bottles.

Per ridurre il consumo di plastica e bottiglie monouso all'interno dei suoi uffici e della produzione, Sovet ha creato delle borracce in metallo.



# made in italy

**The creative use of industrial processes, the use of raw materials of highest quality and the scrupulous work of master craftsmen, allow Sovet to create high quality and 100% Made in Italy collections. Thanks to state-of-the-art industrial automation systems, Sovet is also able to meet also large supply needs for contract spaces, always granting the highest quality standards. The company takes a continuous search path for materials, to create an offer of accessories that complement one another, furnishing different kinds of environments with the maximum freedom when it comes to customization.**

L'impiego creativo dei processi industriali, l'utilizzo di materie prime di assoluta qualità e le scrupolose lavorazioni eseguite da maestranze artigiane, permettono a Sovet di ottenere collezioni di alta qualità e 100% Made in Italy. Grazie a sistemi di automazione industriale all'avanguardia Sovet è in grado di soddisfare anche esigenze per grandi forniture destinate a spazi contract, sempre garantendo i più elevati standard qualitativi. Sovet intraprende un percorso di ricerca dei materiali per creare un'offerta di complementi che si integrino tra di loro, arredando varie tipologie di ambienti con la massima possibilità di personalizzazione.

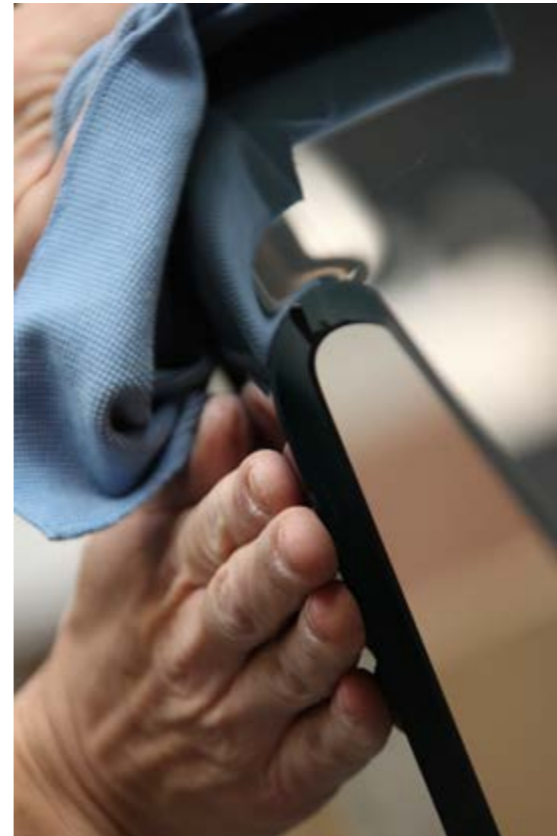





[sovet.com](https://www.sovet.com)