

QUARTZ 72

Design · Riccardo Lucatello

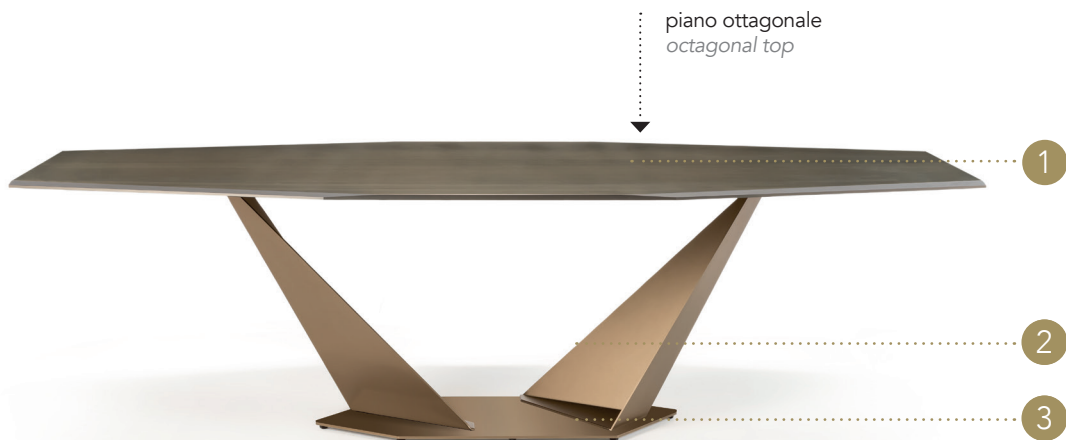

TOP | 1



sp./thick 15 mm.
bisello/bevel 35 mm
filo lucido/polished edges

Vetro
Glass



Trasparente
Transparent

Extrachiaro
Extra clear



sp./thick 15 mm.
bisello/bevel 35 mm

Vetro verniciato
Lacquered glass

finitura/finish

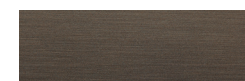

105M Ottone dark satinato
105M Satin dark Brass

MARMOREFLEX®
Vetro Marmo
Marble glass



MATERIAL SHEET-D

LEGNOREFLEX®
Vetro Legno
Wood glass







MATERIAL SHEET-D



sp./thick 10+4 mm.
filo Wing/Wing edge

GAMBE LEGS | 2

Metallo Metal		
	100M Bronze 100M Bronze	104M Ottone satinato 104M Satin Brass
finitura/finish		
	105M Ottone dark satinato 105M Satin dark Brass	101M Titanium satinato 101M Satin titanium

piano ottagonale
octagonal top



ZOCCOLO PLINTH | 3

Metallo Metal
In tinta con le gambe
Matching the legs

**VETRO E VETRO VERNICIATO OTTONE DARK 105M
GLASS AND LACQUERED DARK BRASS 105M GLASS**

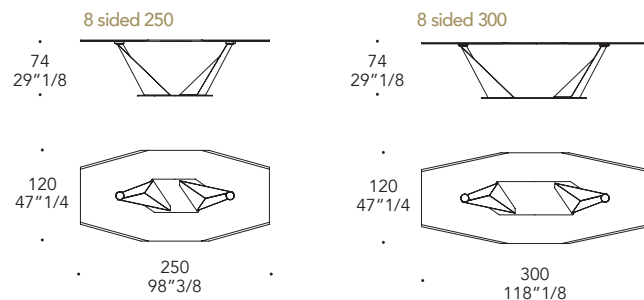

**VETRO, VETRO MARMO E VETRO LEGNO
GLASS, MARBLE GLASS AND WOOD GLASS TOP**

