













Freedom 2.0 divano letto braccioli S

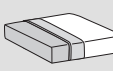

	Seduta - Seat	Schienali - Backrests	Struttura - Structure	
Rivestimento Upholstering (8)	Sfoderabile / Removable  	Sfoderabile / Removable  	Sfoderabile / Removable  	
	Non sfoderabile / Not removable -	Non sfoderabile / Not removable -	Non sfoderabile / Not removable -	
Imbottiture Padding (3-4-5-6-7)	 +  Tecnoform D.35kg/m³		 +  Tecnoform	 ETHICALLY SOFT MADE Optional

INFORMAZIONI TECNICHE

Struttura: 1-6

Telaio di base in acciaio verniciato. Masselli in abete di vari spessori, pannelli di tamponamento in pannelli di particelle di legno in classe E1, compensato o pannelli di fibra di legno dura o cellulosa.

Struttura rivestita completamente in lastre di poliuretano espanso e Tecnoform.

Molleggio: 1-2

Schienale in pannelli di particelle di legno in classe E1 e pannelli di fibra di legno dura o cellulosa.

Seduta in nastri elastici incrociati del meccanismo rete.

Note:

Caratteristiche relative ai materiali utilizzati descritte nella sezione tecnica a fine listino.

Set biancheria da letto e coprirete disponibili nella sezione accessori per letti.

TECHNICAL INFORMATION

Structure: 1-6

Supporting structure in polished steel, varnished with high resistance powders. Remaining parts in wooden E1 class agglomeration panels or cellulose agglomeration panels.

Structure completely covered with foam and Tecnoform.

Springing: 1-2

Backrest in class E1 particleboard panels and hard or cellulose wood fibre panels.

Seat in crisscross belts of the bed base mechanism.

Notes:





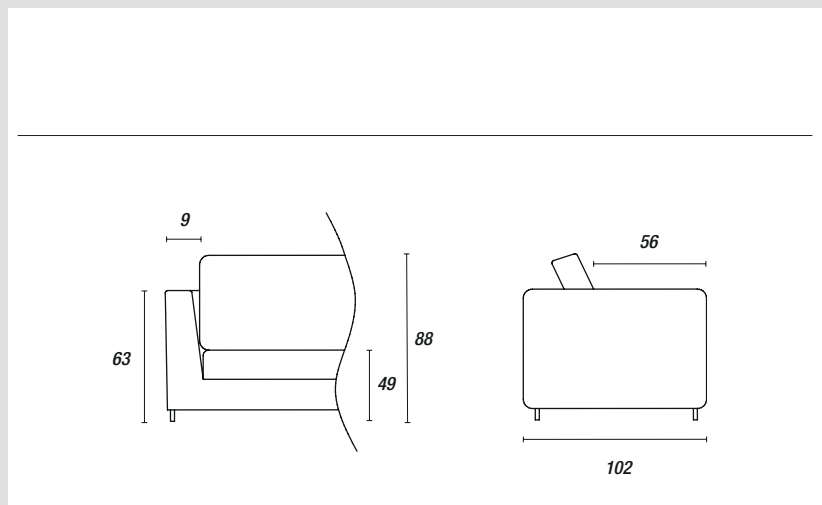
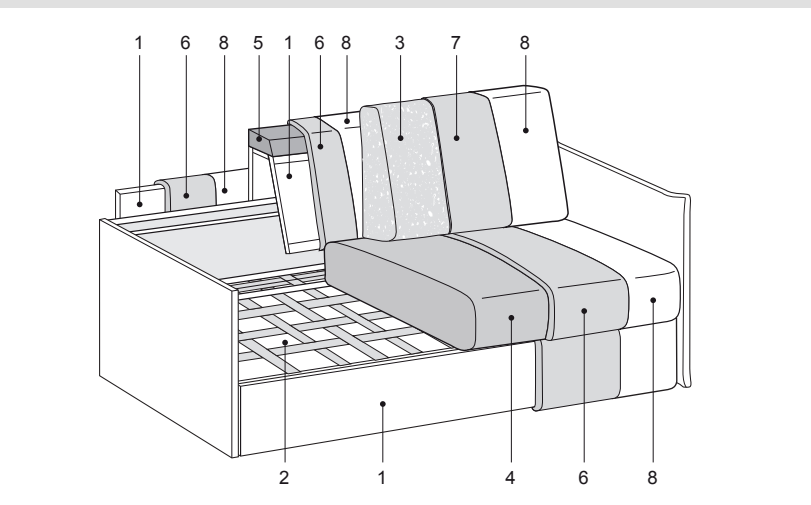







For characteristics related to the materials used, see the technical section at the end of the pricelist.

Bed linen and bed-base cover set available in the section "Bed accessories"

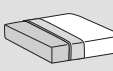

Freedom 2.0 divano letto braccioli L



	Seduta - Seat	Schienali - Backrests	Struttura - Structure	
Rivestimento Upholstering (8)	Sfoderabile / Removable Non sfoderabile / Not removable  	 	 	
Imbottiture Padding (3-4-5-6-7)	 +  D.35kg/m³		 	 Optional

INFORMAZIONI TECNICHE

Struttura: 1-6

Telaio di base in acciaio verniciato. Masselli in abete di vari spessori, pannelli di tamponamento in pannelli di particelle di legno in classe E1, compensato o pannelli di fibra di legno dura o cellulosa.

Struttura rivestita completamente in lastre di poliuretano espanso e Tecnoform.

Molleggio: 1-2

Schienale in pannelli di particelle di legno in classe E1 e pannelli di fibra di legno dura o cellulosa.

Seduta in nastri elastici incrociati del meccanismo rete.

Note:

Caratteristiche relative ai materiali utilizzati descritte nella sezione tecnica a fine listino.

Set biancheria da letto e copirete disponibili nella sezione accessori per letti.

TECHNICAL INFORMATION

Structure: 1-6

Supporting structure in polished steel, varnished with high resistance powders. Remaining parts in wooden E1 class agglomeration panels or cellulose agglomeration panels.

Structure completely covered with foam and Tecnoform.

Springing: 1-2

Backrest in class E1 particleboard panels and hard or cellulose wood fibre panels.

Seat in crisscross belts of the bed base mechanism.

Notes:

For characteristics related to the materials used, see the technical section at the end of the pricelist.

Bed linen and bed-base cover set available in the section "Bed accessories"

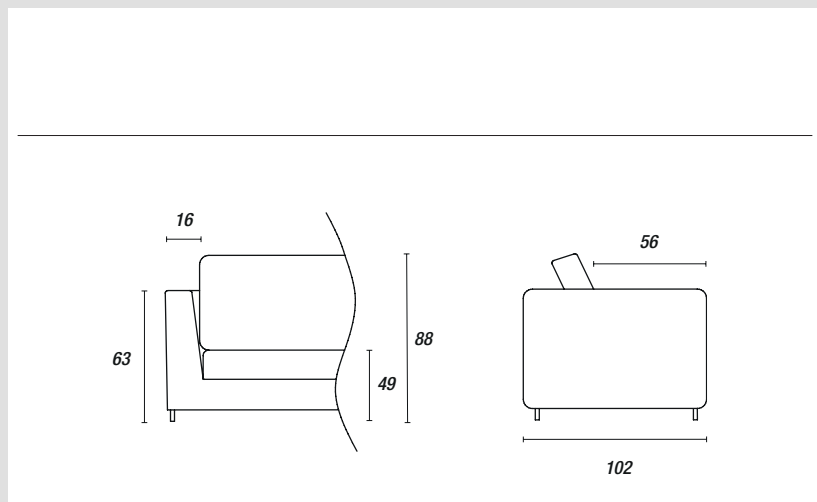
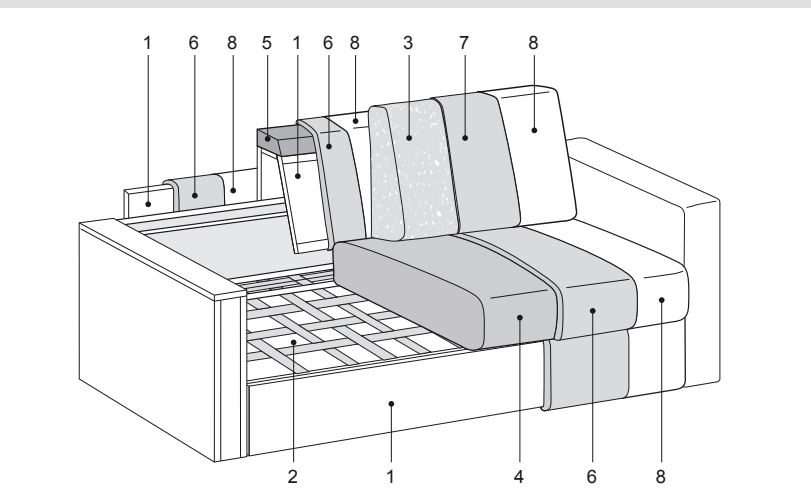

Freedom 2.0 divano letto braccioli XL



	Seduta - Seat	Schienali - Backrests	Struttura - Structure	
Rivestimento Upholstering (8)	Sfoderabile / Removable Non sfoderabile / Not removable	Sfoderabile / Removable Non sfoderabile / Not removable	Sfoderabile / Removable Non sfoderabile / Not removable	
Imbottiture Padding (3-4-5-6-7)	D.35kg/m³ Tecnoform	Tecnoform	Tecnoform	ECOSY ETHICALLY SOFT MADE Optional

INFORMAZIONI TECNICHE

Struttura: 1-6

Telaio di base in acciaio verniciato. Masselli in abete di vari spessori, pannelli di tamponamento in pannelli di particelle di legno in classe E1, compensato o pannelli di fibra di legno dura o cellulosa.

Struttura rivestita completamente in lastre di poliuretano espanso e Tecnoform.

Molleggio: 1-2

Schienale in pannelli di particelle di legno in classe E1 e pannelli di fibra di legno dura o cellulosa.

Seduta in nastri elastici incrociati del meccanismo rete.

Note:

Caratteristiche relative ai materiali utilizzati descritte nella sezione tecnica a fine listino.

Set biancheria da letto e coprirete disponibili nella sezione accessori per letti.

TECHNICAL INFORMATION

Structure: 1-6

Supporting structure in polished steel, varnished with high resistance powders. Remaining parts in wooden E1 class agglomeration panels or cellulose agglomeration panels.

Structure completely covered with foam and Tecnoform.

Springing: 1-2

Backrest in class E1 particleboard panels and hard or cellulose wood fibre panels.

Seat in crisscross belts of the bed base mechanism.

Notes:

For characteristics related to the materials used, see the technical section at the end of the pricelist.

Bed linen and bed-base cover set available in the section "Bed accessories"

