



	Seduta - Seat	Schienali - Backrests	Struttura - Structure	
Rivestimento Upholstering (8)	Sfoderabile / Removable 	Sfoderabile / Removable 	Sfoderabile / Removable 	
	Non sfoderabile / Not removable -	Non sfoderabile / Not removable -	Non sfoderabile / Not removable 	
Imbottiture Padding (4-5-6-7)				 Optional

INFORMAZIONI TECNICHE

Struttura: 1

Struttura base in pannelli di legno multistrati in classe E1, Elementi strutturali in pannelli di particelle di legno in classe E1 e tamponamenti in faesite.

Molleggio: 1-2

Schienale in pannello di particelle di legno.
 Seduta in nastri elastici di fibra propilenica e lattice incrociati e meccanicamente pretensionati.

Note:

Per piedini opzionali Bjorg nella finitura (ME05) cromo nero o (ME13) pettro applicare la maggiorazione indicata nella sezione "Piedini disponibili".

TECHNICAL INFORMATION

Structure: 1

Frame structure in plywood panels in class E1, Structural elements in wood particle panels in class E1 and infill in faesite.

Springing: 1-2

Back panel made of wood particles.
 Seat with pre-tensioned crossed propylene fibre and latex elastic webbing.

Note:

For optional Bjorg feet available in the finish (ME04) shiny chrome or (ME13) pettro apply the surcharge that it's indicated in the section "available feet".

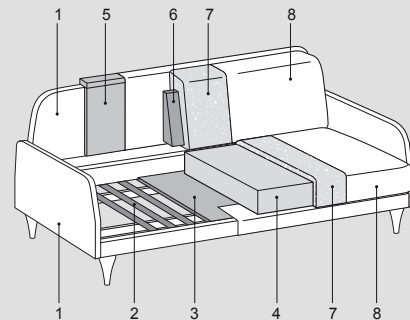
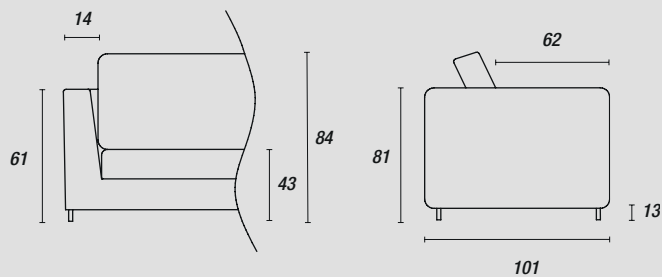







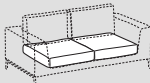
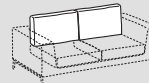
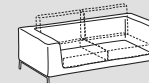

Piedini - Feet:

di serie H.13cm Eucalipto (LE05)	optional Bamboo H.13cm con maggiorazione Nero (ME09)	optional Bjorg H.13cm Nero (ME09) Light brown (ME11) Antracite (ME01) Testa di moro (ME03)	optional Bjorg H.13cm con maggiorazione Cromo nero (ME05) Pettro (ME13)
---	---	--	---

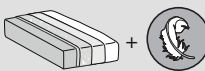
Elliot mix



	 Seduta - Seat	 Schienali - Backrests	 Struttura - Structure	
Rivestimento Upholstering (8)	Sfoderabile Removable 	Sfoderabile Removable 	-	
	Non sfoderabile Not removable -	-		
Imbottiture Padding (4-5-6-7)	 D.35kg/m³	 D.21kg/m³	 Pol.espanso Tecnoform	 Optional

INFORMAZIONI TECNICHE

Struttura: 1

Struttura base in pannelli di legno multistrati in classe E1, Elementi strutturali in pannelli di particelle di legno in classe E1 e tamponamenti in faesite.

Molleggio: 1-2

Schienale in pannello di particelle di legno.
Seduta in nastri elastici di fibra propilenica e lattice incrociati e meccanicamente pretensionati.

Note:

Parte esterna della scocca rivestita in pelle, parte interna in tessuto, per articolo imbottito con parti in pelle di altre categorie, aggiungere la maggiorazione indicata; per scocca interamente rivestita in pelle applicare una maggiorazione del 10%.
Per piedini opzionali Bjorg nella finitura (ME05) cromo nero o (ME13) peltro applicare la maggiorazione indicata nella sezione "Piedini disponibili".

TECHNICAL INFORMATION

Structure: 1

Frame structure in plywood panels in class E1, Structural elements in wood particle panels in class E1 and infill in faesite.

Springing: 1-2



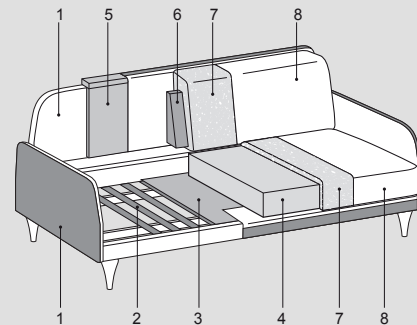
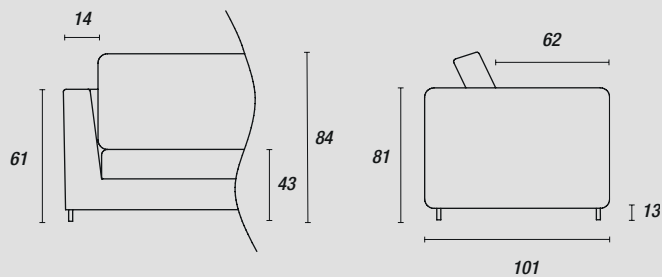

Back panel made of wood particles.
Seat with pre-tensioned crossed propylene fibre and latex elastic webbing.

Note:

External part of the structure covered by leather, internal part in fabric, for articles upholstered with leather parts from other categories, consider the indicated surcharge; for sofas with body completely covered in leather please apply 10% surcharge.
For optional Bjorg feet available in the finish (ME04) shiny chrome or (ME13) peltro apply the surcharge that it's indicated in the section "available feet".



Piedini - Feet:

di serie  H.13cm Eucalipto (LE05)	optional Bamboo  H.13cm con maggiorazione Nero (ME09)	optional Bjorg  H.13cm Nero (ME09) Light brown (ME11) Antracite (ME01) Testa di moro (ME03)	optional Bjorg  H.13cm con maggiorazione Cromo nero (ME05) Peltro (ME13)
--	---	---	---